

TECHNICAL CHARACTERISTICS

The tank mounted filters HF 502 and HF 508 series are specifically designed to be directly connected on the return line of hydraulic circuit to safeguard it from contaminating particles.

HF 508 series is available with double inlet port with SAE 3000 threads.

- Flow up to 264 US gpm (1000 l/min)
- Extension on the oil way out of the pipe union
- Fluid-decelerating diffuser

MATERIALS

Cover	Aluminum
Housing	Aluminum
Bowl (1)	Reinforced nylon Steel
Seals	Buna - Viton
End cap	Zinc plated steel
Inner tube	Zinc plated steel Steel Stainless steel
Filter media	Cellulose Reinforced cellulose Micro-fibre glass

(1) The filters of dimensions 10.060, 10.129, 20.077, 20.122, 20.201, 20.280 and 30.195 are supplied with a nylon-reinforced bowl. Varnished steel bowl is available on request.

The filters of dimensions 30.239, 40.122, 40.194, 40.195, 40.239, 40.390 and 40.512 are only supplied with a varnished steel bowl.

FLUID COMPATIBILITY

Conforming to ISO 2943 (Norm ISO 6743/4)

Oli mineral (2)	HH - HL - HM - HR - HV - HG
Water emulsion (2)	HFAE - HFAS
Syntetic fluid (3)	HS - HFDR - HFDU - HFDS

(2) With Buna seals

(3) With Viton seals

FLOW

Flow max.	264 US gpm (1000 l/min)
-----------	-------------------------

PRESSURE

Working pressure	116 psi (8 bar)
Testing pressure	174 psi (12 bar)
Burst pressure	232 psi (16 bar)
Element collapse pressure rating (conforming to ISO 2941)	145 psi (10 bar)

BY-PASS VALVE

By-pass setting	25 psi (1,7 bar)
-----------------	------------------

OPERATING TEMPERATURE

With Buna seals	-22 ÷ 195 °F (-30 ÷ 90 °C)
With Viton seals	-4 ÷ 230 °F (-20 ÷ 110 °C)

DEGREE OF FILTRATION

Absolute Filtration

Code	Material	Degree of filtration
FG003	Micro-fibre glass	3 µm
FG006	Micro-fibre glass	6 µm
FG010	Micro-fibre glass	10 µm
FG025	Micro-fibre glass	25 µm

Nominal Filtration

Code	Material	Degree of filtration
SP010	Cellulose	10 µm
RP010	Reinforced cellulose	10 µm
SP025	Cellulose	25 µm
RP025	Reinforced cellulose	25 µm
MI025	Stainless steel	25 µm
MI060	Stainless steel	60 µm
MS090	Steel	90 µm
MI125	Stainless steel	125 µm

INDICATORS (4)

Rear manometer
Radial manometer
Visual indicator
Electrical indicator

(4) Characteristics and dimensions at page 30

01/07.2010

SIZING – PRESSURE DROP

The total pressure drop of the filter is calculated by summing the pressure drop value in the housing to the one in the filtering element.

$$\text{Total } \Delta p = \Delta p \text{ in housing} + \Delta p \text{ in element}$$

In filters of HF 502 and HF 508 series in normal working conditions, the total Δp must not be more than 5.8 psi (0,4 bar). To establish the values of pressure drop involved, the following pages provide some diagrams with curves referred to the use of mineral oils SAE 10 with kinematic viscosity of 120 SSU (30 cSt) and density of 7.29 lb/gal (0,856 kg/dm³).

Calculation example

Filter HF502-30.239-AS-RP025-B17-GH-B-H-Z-XN-G-YN-K

Flow rate= 77 US gpm (290 l/min)

Kinematic viscosity: 120 SSU (30 cSt)

Oil density : 7.29 lb/gal (0,856 kg/dm³)

Filtration degree: 25 μm

Data obtained from the diagrams:

Δp in housing = 4.93 psi (0,34 bar) (page 5)

Δp in element = 0,87 psi (0,06 bar) (page 14)

Total $\Delta p = 4.93 + 0.87 = 5.8$ psi (0,4 bar) (Δp is lower than maximum value admitted – therefore sizing is correct).

If oil with different kinematic viscosity and different density is used, the values obtained from the diagrams will be re-calculated considering the following indications:

1) The pressure drop of the housing is proportional with the oil density, therefore for oil with density different to 7.29 lb/gal (0,856 kg/dm³) the value of the Δp in the head-bowl will be:

$$\Delta p \text{ in housing} = \frac{\Delta p \text{ of diagram (psi)} \cdot \text{Oil density (lb/gal)}}{7.29 \text{ (lb/gal)}} \quad [\text{psi}]$$

Or

$$\Delta p \text{ in housing} = \frac{\Delta p \text{ of diagram (bar)} \cdot \text{Oil density (kg/dm}^3\text{)}}{0,856 \text{ (kg/dm}^3\text{)}} \quad [\text{bar}]$$

2) The pressure drop of the element is proportional with the oil density and kinematic viscosity, therefore for oil with density different to 7.29 lb/gal (0,856 kg/dm³) and kinematic viscosity different to 120 SSU (30 cSt) the value of Δp in the element will be:

$$\Delta p \text{ element} = \Delta p \text{ of diagram (psi)} \cdot \frac{\text{Oil density (lb/gal)}}{7.29 \text{ (lb/gal)}} \cdot \frac{\text{Oil viscosity (SSU)}}{120 \text{ (SSU)}} \quad [\text{psi}]$$

Or

$$\Delta p \text{ element} = \Delta p \text{ of diagram (bar)} \cdot \frac{\text{Oil density (kg/dm}^3\text{)}}{0,856 \text{ (kg/dm}^3\text{)}} \cdot \frac{\text{Oil viscosity (cSt)}}{30 \text{ (cSt)}} \quad [\text{bar}]$$

Now you sum the values of the pressure drop of the housing to the value of the pressure drop of the filtering element, always making sure the total Δp does not exceed the pressure limit of 5.8 psi (0,4 bar).

01/07.2010

PRESSURE DROP CURVES THROUGH THE BY-PASS VALVES

The pressure drop values are directly proportional with the specific weight of the fluid and do not affect the establishment of the total pressure drop of the complete filter.

The curves are obtained in the following conditions:
Mineral oil type SAE 10
Kinematic viscosity 120 SSU (30 cSt)
Density 7.29 lb/gal (0,856 kg/dm³).

HF 502-10

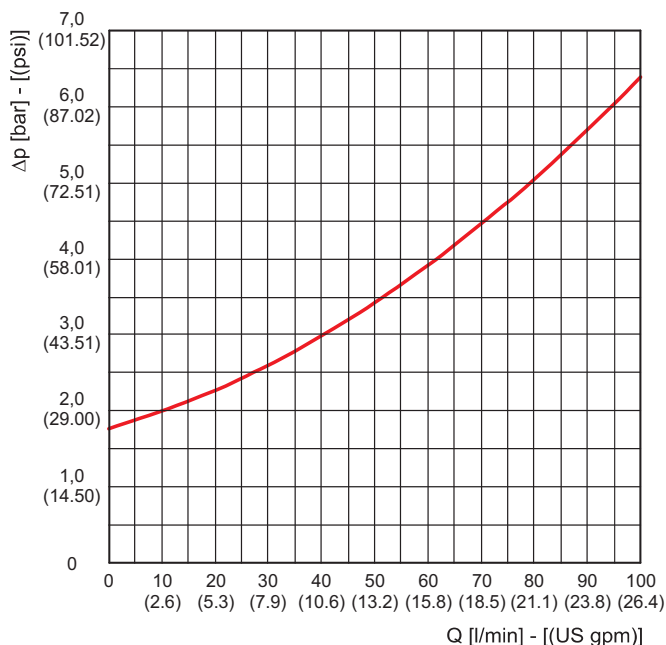

HF 502-20

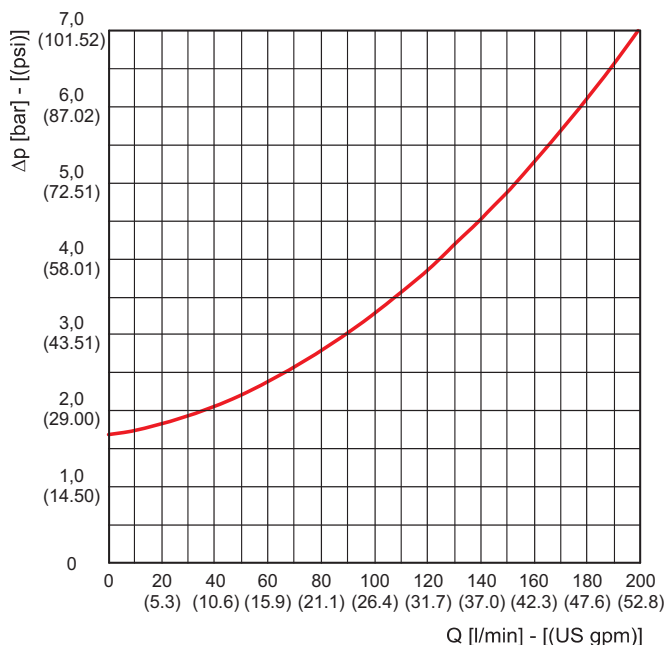

HF 502 / HF 508-30

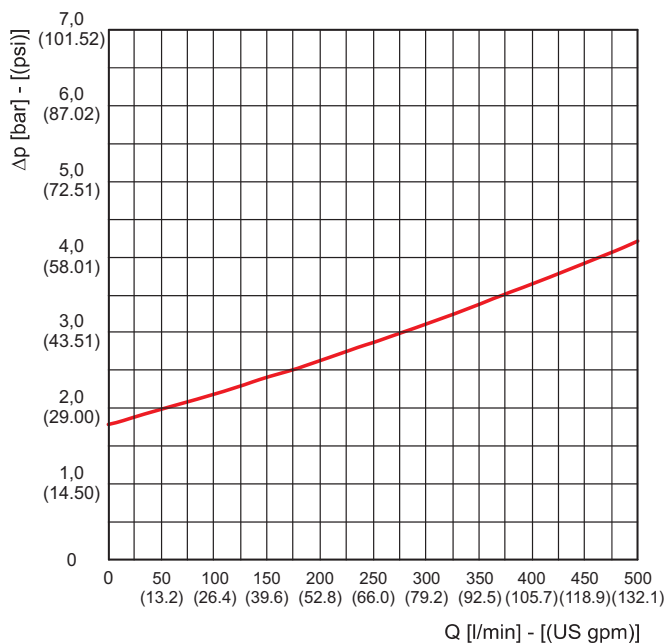

HF 502 / HF 508-40

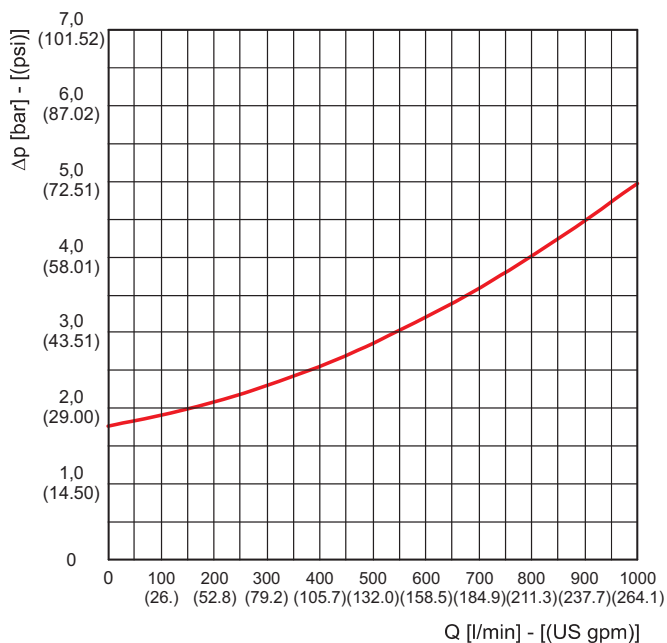

01/07.2010

PRESSURE DROP CURVES THROUGH THE HOUSING

The curves are obtained in the following conditions:
 Mineral oil type SAE 10
 Kinematic viscosity 120 SSU (30 cSt)
 Density 7.29 lb/gal (0,856 kg/dm³).

- (1) G 3/8
- (2) G 1/2
- (3) G 3/4
- (4) G 1
- (5) G 1 1/4

HF 502-10.060 / 10.129

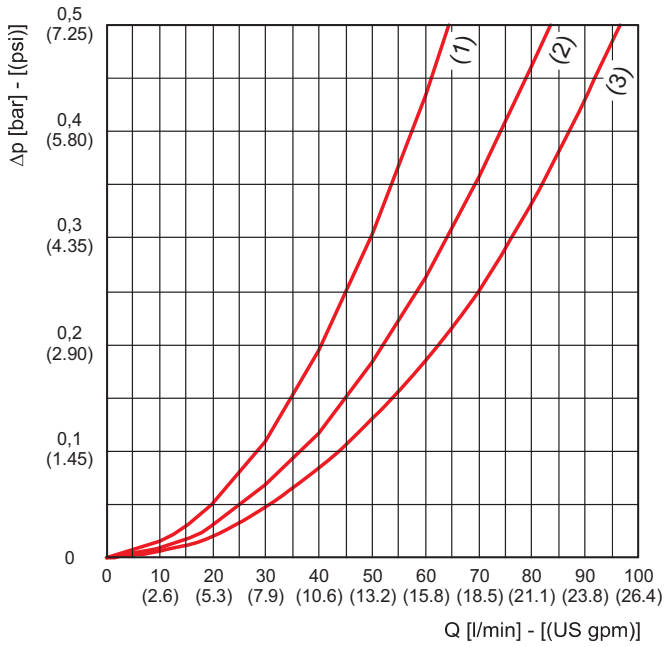

HF 502-20.077 / 20.122

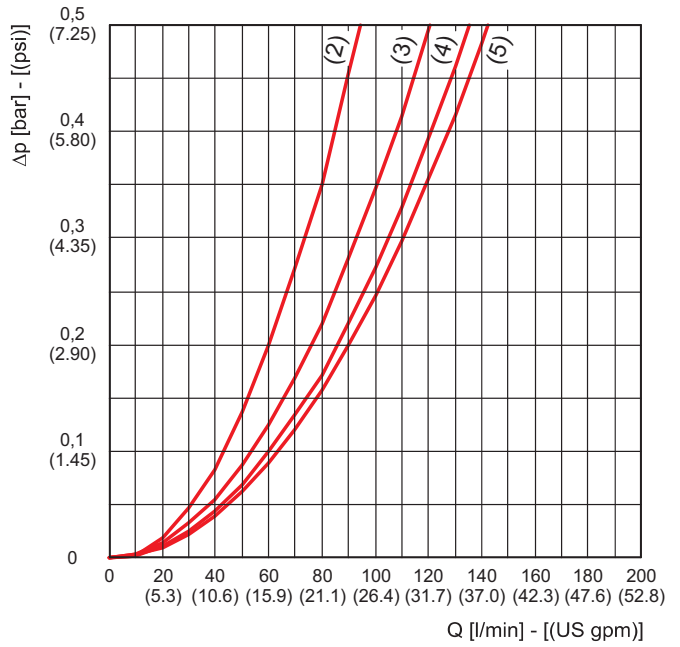

HF 502-20.201 / 20.280

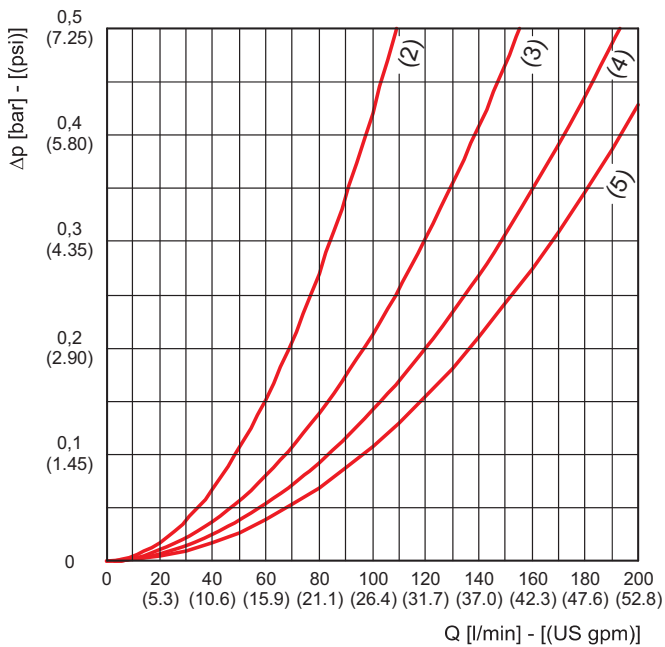

01/07.2010

PRESSURE DROP CURVES THROUGH THE HOUSING

The curves are obtained in the following conditions:

Mineral oil type SAE 10

Kinematic viscosity 120 SSU (30 cSt)

Density 7.29 lb/gal (0,856 kg/dm³).

(4) G 1

(5) G 1 1/4

(6) G 1 1/2

(7) G 2

HF 502-30.195 / 30.239

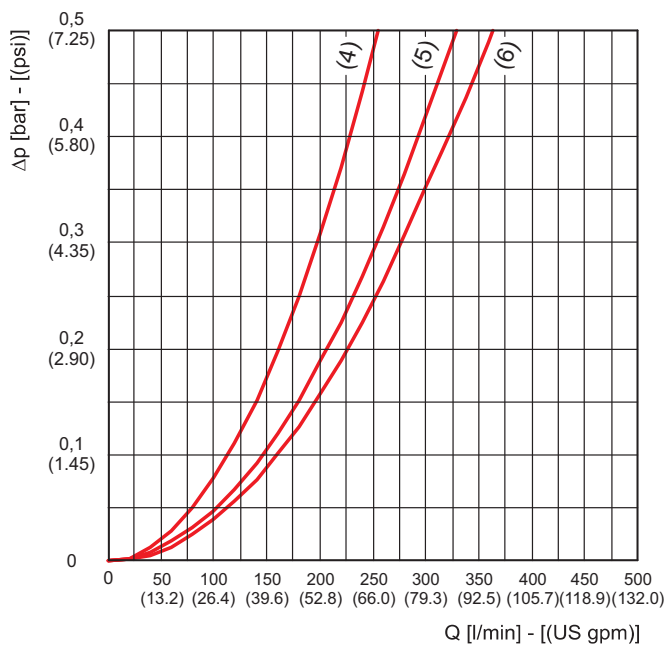

HF 502-40.122 / 40.194

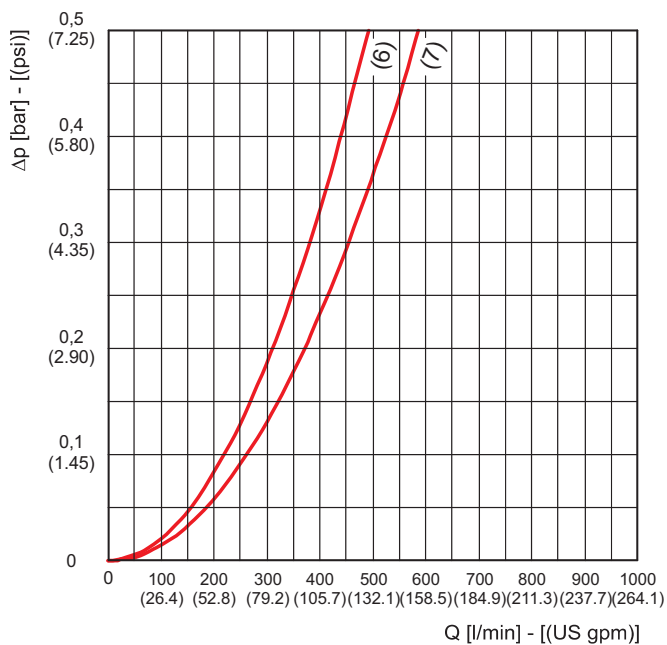

HF 502-40.195 / 40.239 / 40.390 / 40.512

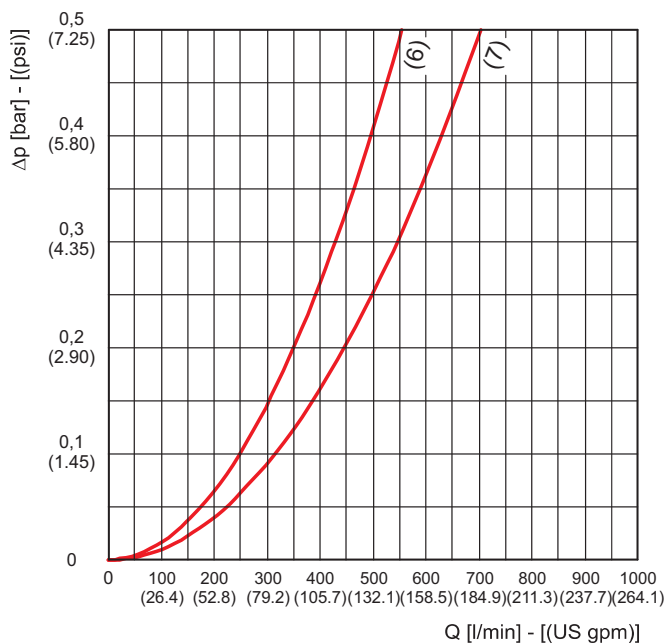

01/07.2010

PRESSURE DROP CURVES THROUGH THE HOUSING

The curves are obtained in the following conditions:
 Mineral oil type SAE 10
 Kinematic viscosity 120 SSU (30 cSt)
 Density 7.29 lb/gal (0,856 kg/dm³).

- (1) 1 1/4 - 1 1/4 (4) 1 1/2 - 2
- (2) 1 1/4 - 1 1/2 (5) 2 - 2
- (3) 1 1/2 - 1 1/2 (6) 2 - 2 1/2

HF 508-30.195 / 30.239

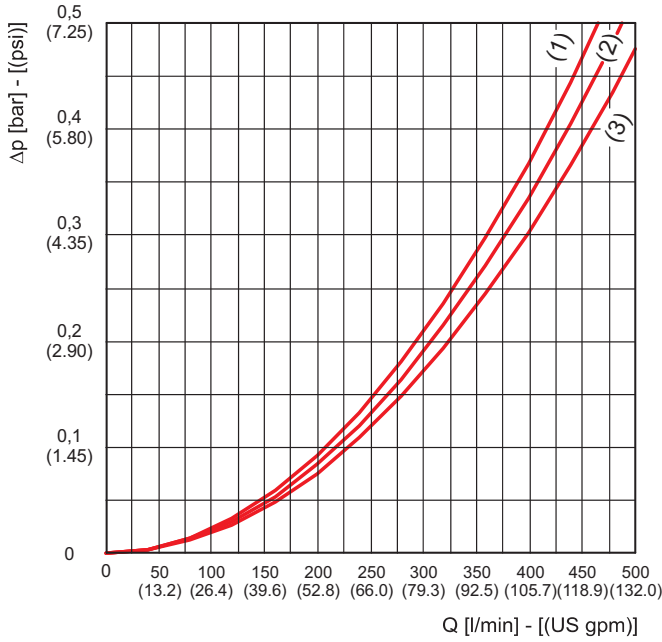

HF 508-40.122 / 40.194

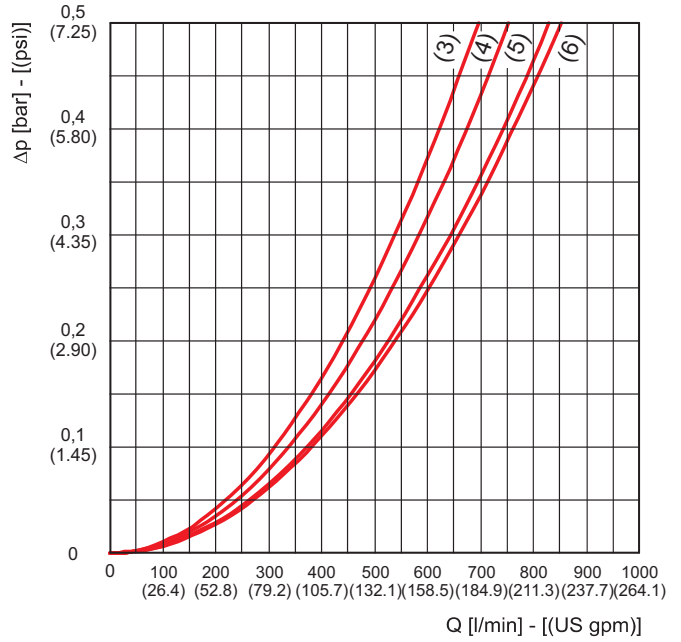

HF 508-40.195 / 40.239 / 40.390 / 40.512

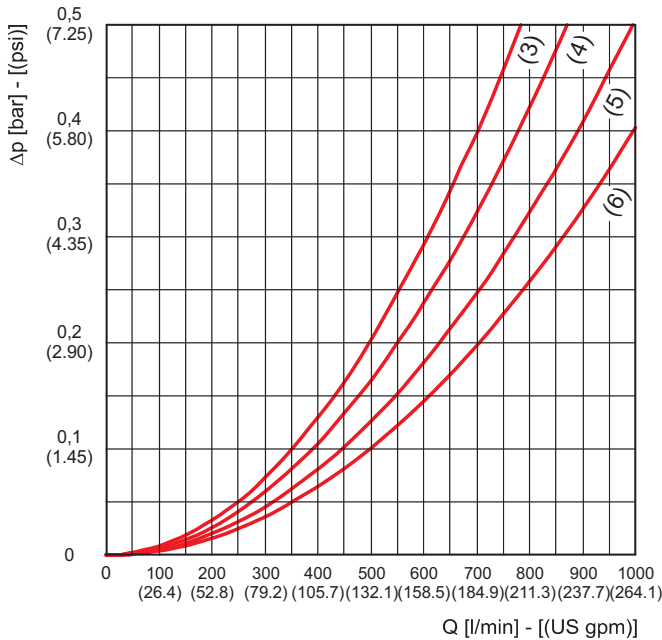

01/07.2010

PRESSURE DROP CURVES THROUGH THE ELEMENT HEK02-10

The curves are obtained in the following conditions:
 Mineral oil type SAE 10
 Kinematic viscosity 120 SSU (30 cSt)
 Density 7.29 lb/gal (0,856 kg/dm³).

- (1) HE K02-10.060
- (2) HE K02-10.129

FG003

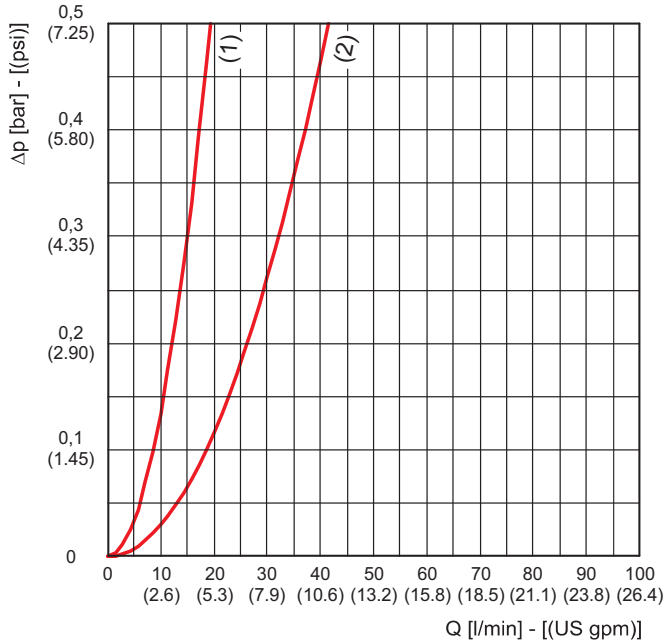

FG006

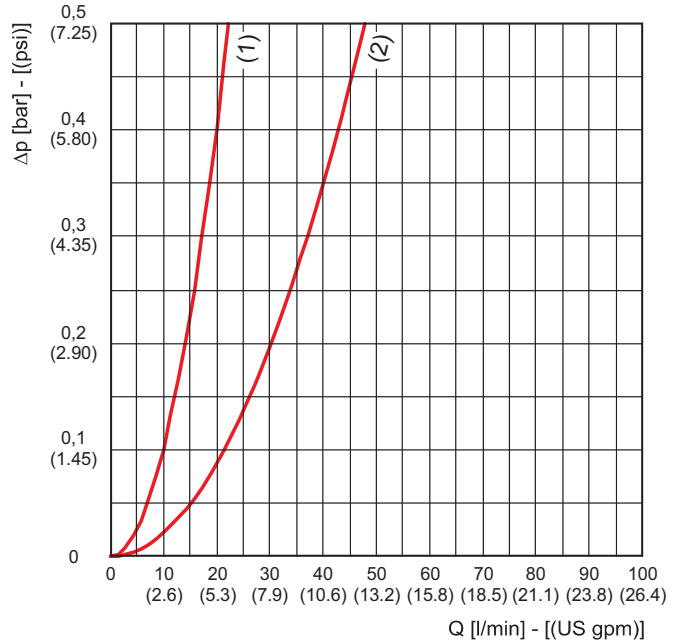

FG010

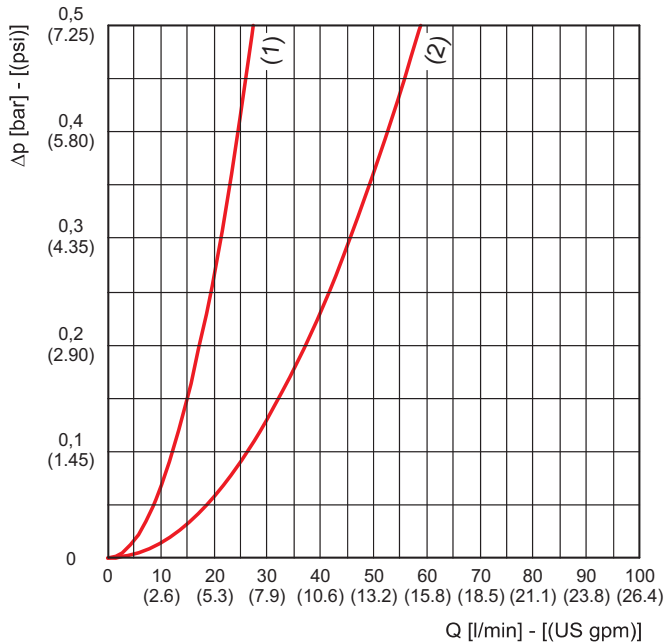

FG025

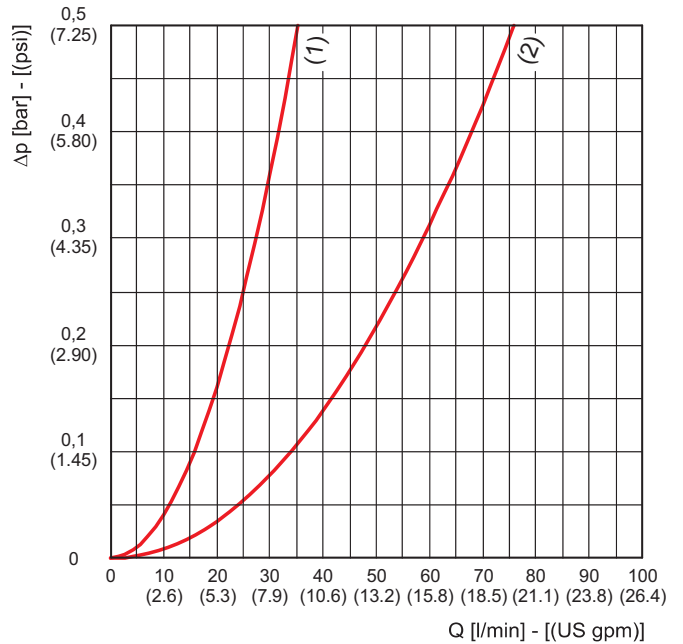

01/07.2010

PRESSURE DROP CURVES THROUGH THE ELEMENT HEK02-10

The curves are obtained in the following conditions:
 Mineral oil type SAE 10
 Kinematic viscosity 120 SSU (30 cSt)
 Density 7.29 lb/gal (0,856 kg/dm³).

- (1) HE K02-10.060
- (2) HE K02-10.129

RP010 / SP010

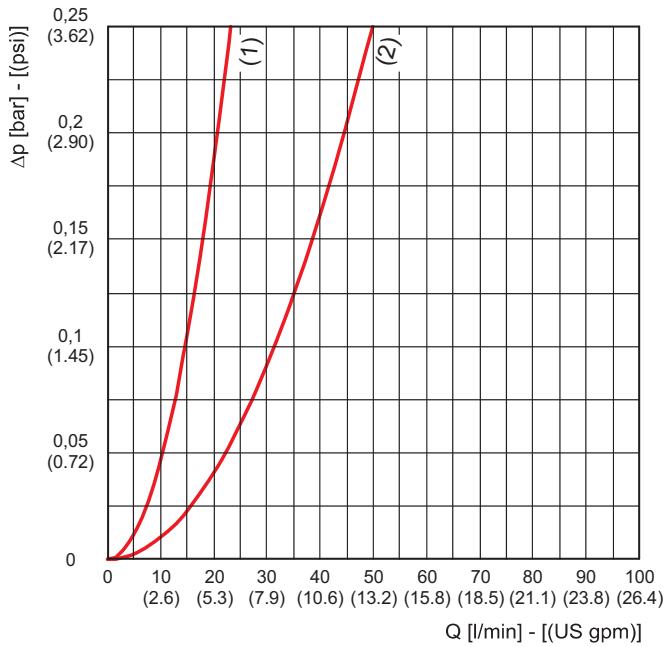

RP025 / SP025

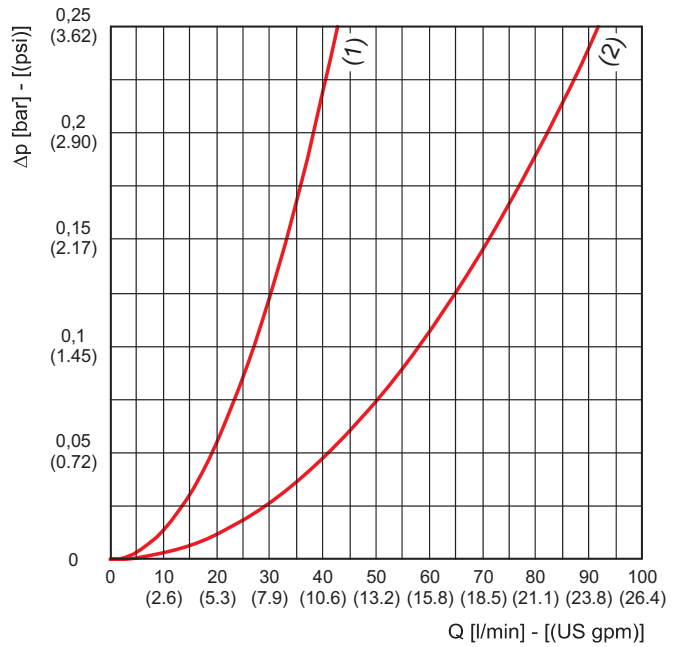

01/07.2010

PRESSURE DROP CURVES THROUGH THE ELEMENT HEK02-10

The curves are obtained in the following conditions:

Mineral oil type SAE 10

Kinematic viscosity 120 SSU (30 cSt)

Density 7.29 lb/gal (0,856 kg/dm³).

(1) HE K02-10.060

(2) HE K02-10.129

MI025

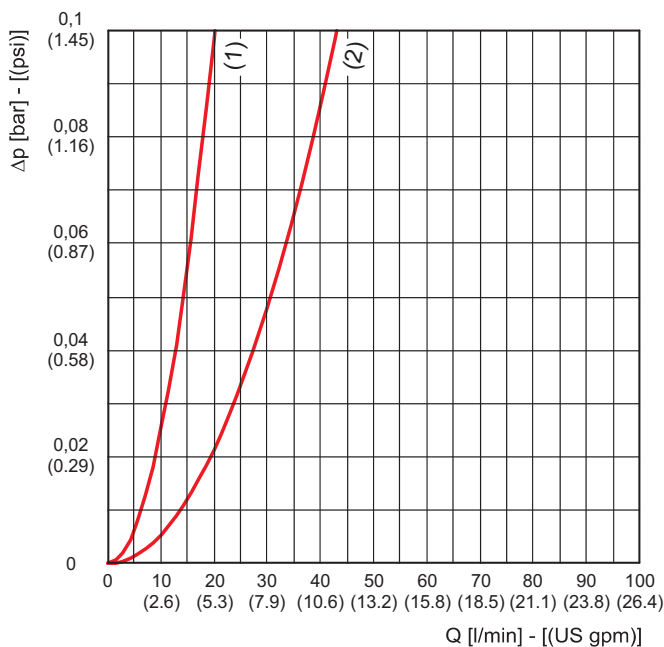

MI060

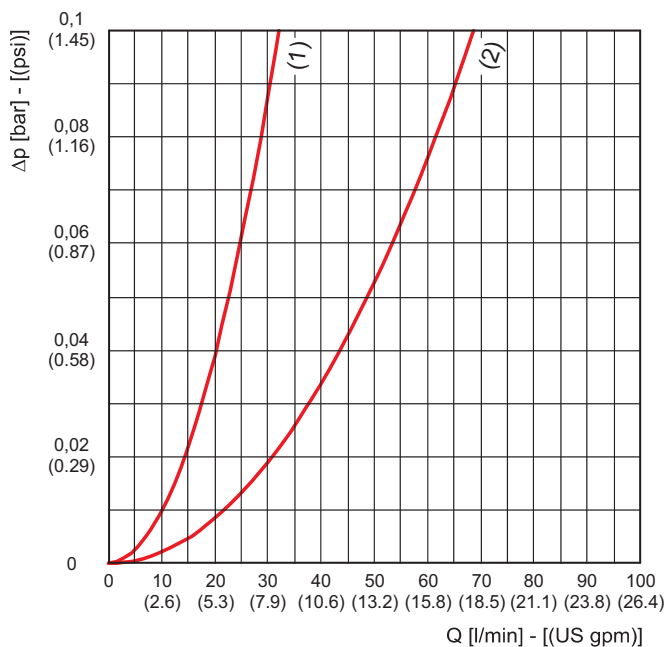

MS090

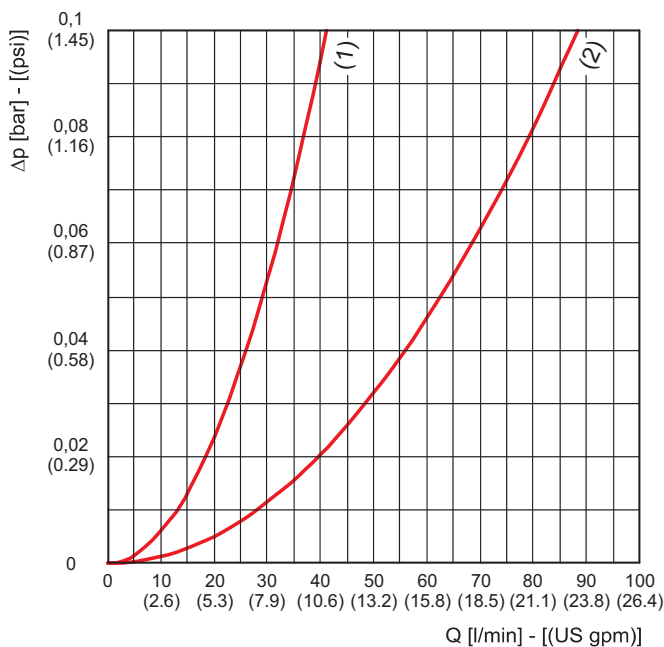

MI125

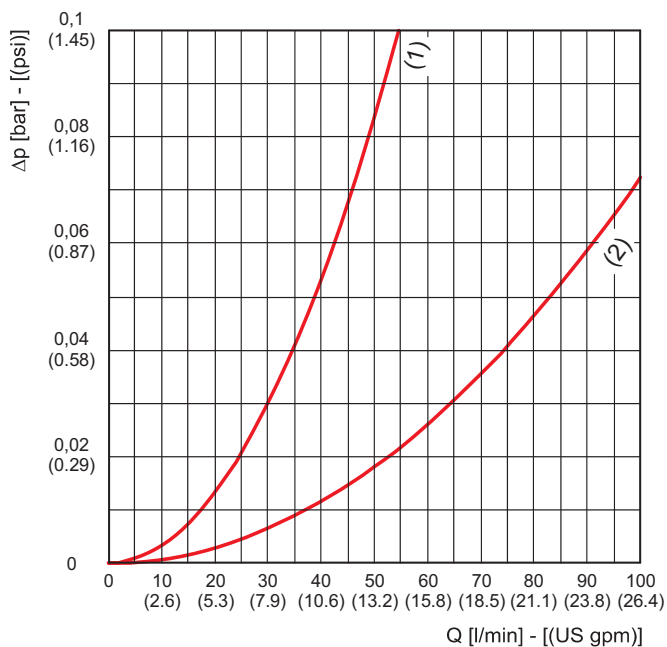

01/07.2010

PRESSURE DROP CURVES THROUGH THE ELEMENT HEK02-20

The curves are obtained in the following conditions:
 Mineral oil type SAE 10
 Kinematic viscosity 120 SSU (30 cSt)
 Density 7.29 lb/gal (0,856 kg/dm³).

- (1) HEK02-20.077
- (2) HEK02-20.122
- (3) HEK02-20.201
- (4) HEK02-20.280

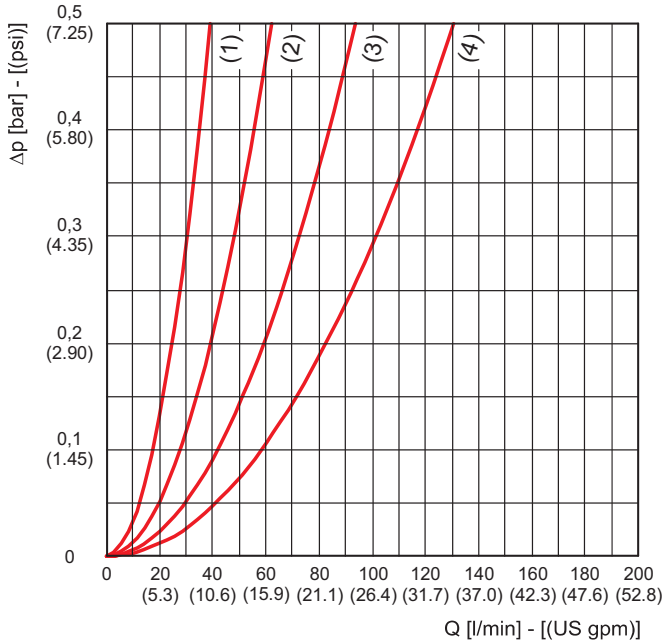
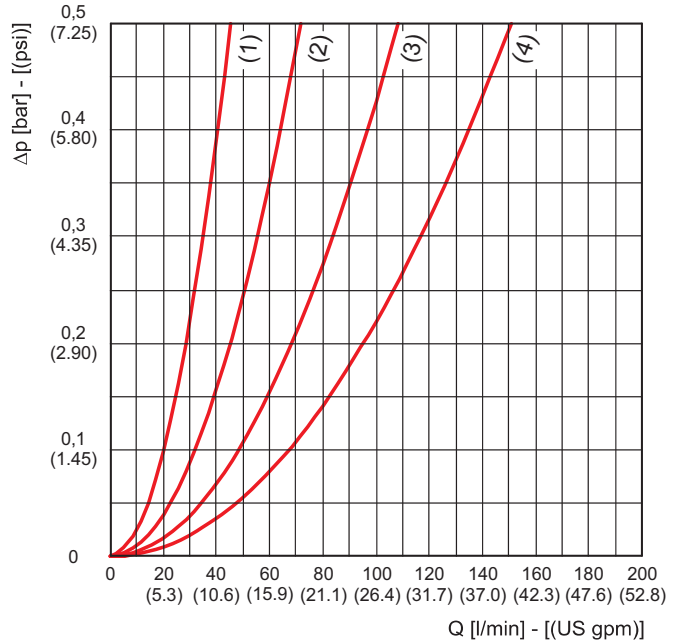
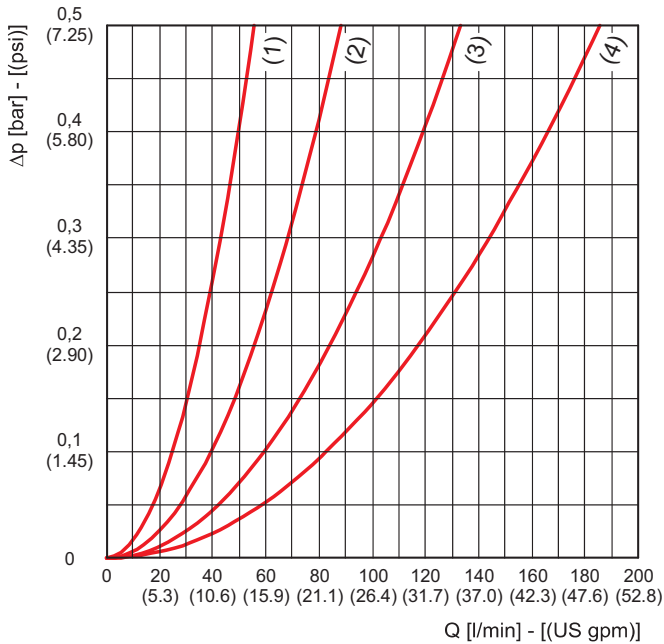
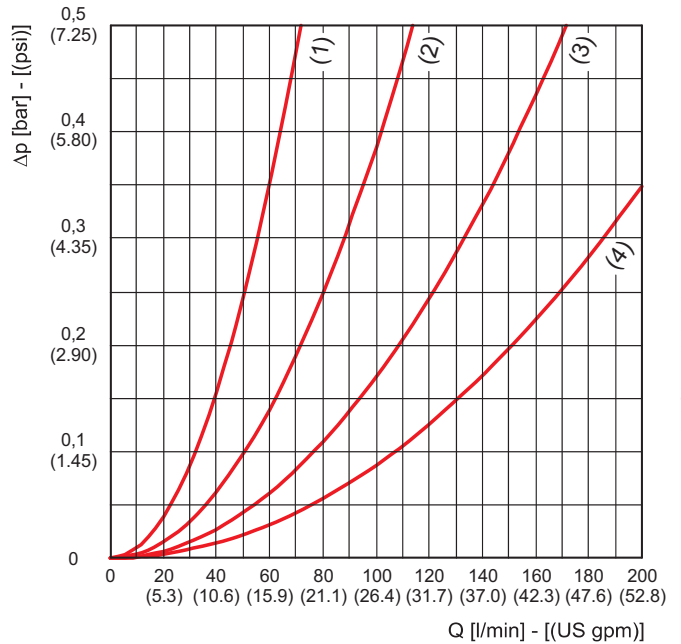
FG003

FG006

FG010

FG025

01/07.2010

PRESSURE DROP CURVES THROUGH THE ELEMENT HEK02-20

The curves are obtained in the following conditions:

Mineral oil type SAE 10

Kinematic viscosity 120 SSU (30 cSt)

Density 7.29 lb/gal (0,856 kg/dm³).

(1) HEK02-20.077

(2) HEK02-20.122

(3) HEK02-20.201

(4) HEK02-20.280

RP010 / SP010

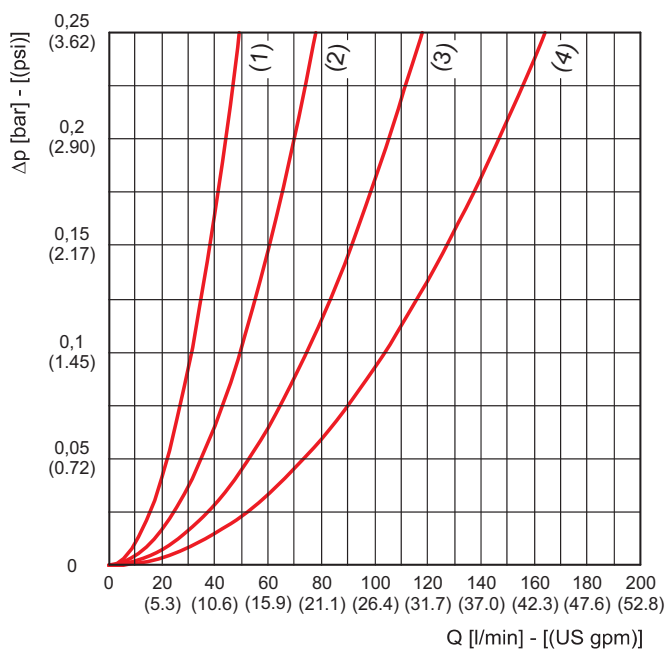

RP025 / SP025

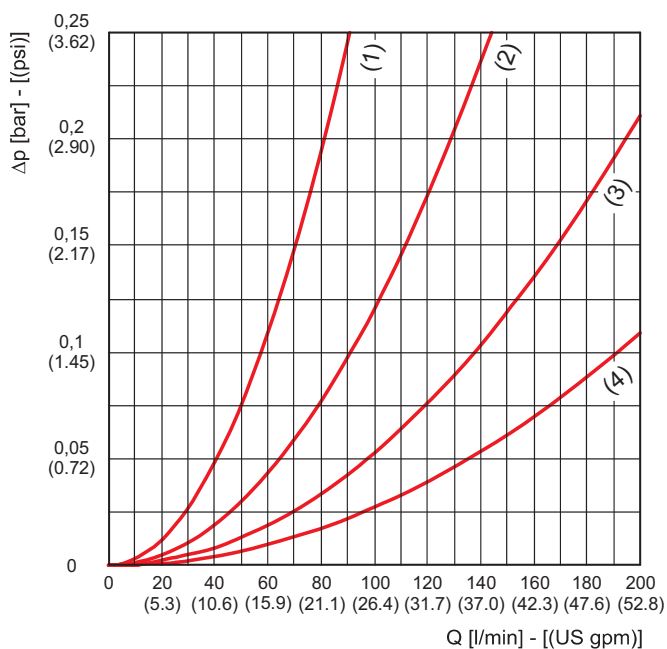

01/07.2010

PRESSURE DROP CURVES THROUGH THE ELEMENT HEK02-20

The curves are obtained in the following conditions:
 Mineral oil type SAE 10
 Kinematic viscosity 120 SSU (30 cSt)
 Density 7.29 lb/gal (0,856 kg/dm³).

- (1) HEK02-20.077
- (2) HEK02-20.122
- (3) HEK02-20.201
- (4) HEK02-20.280

MI025

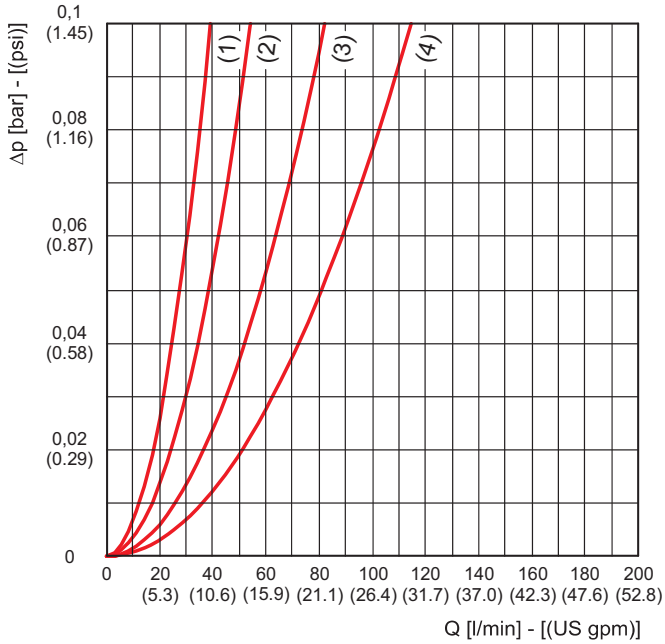

MI060

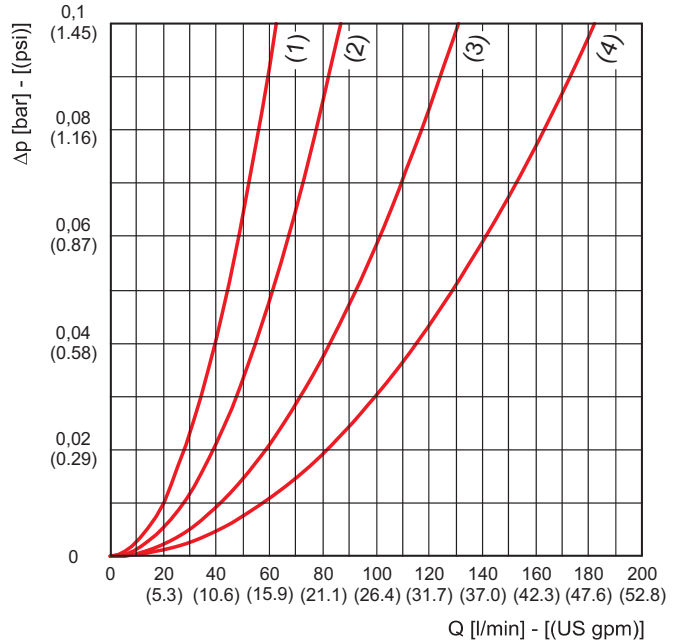

MS090

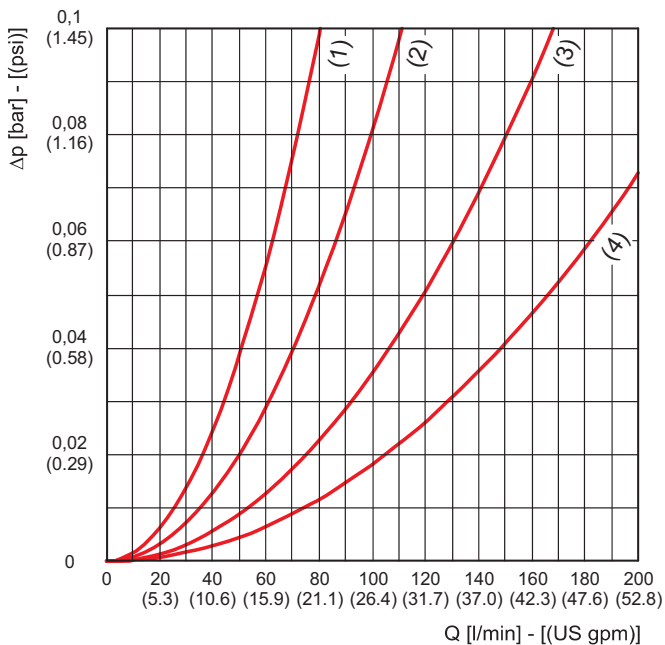

MI125

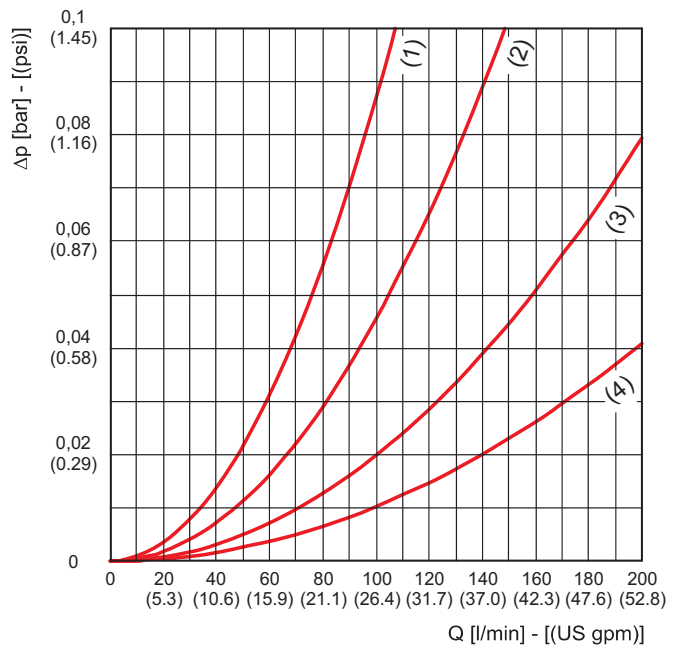

01/07.2010

PRESSURE DROP CURVES THROUGH THE ELEMENT HEK02-30

The curves are obtained in the following conditions:

Mineral oil type SAE 10

Kinematic viscosity 120 SSU (30 cSt)

Density 7.29 lb/gal (0,856 kg/dm³).

(1) HEK02-30.195

(2) HEK02-30.239

FG003

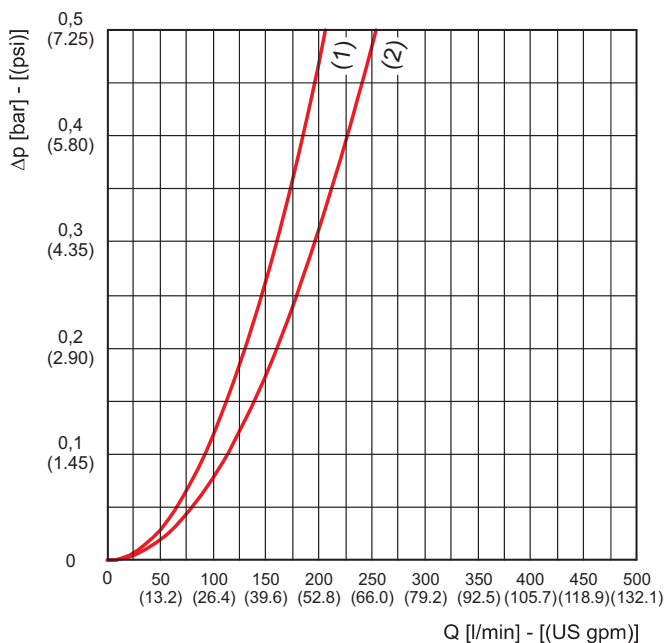

FG006

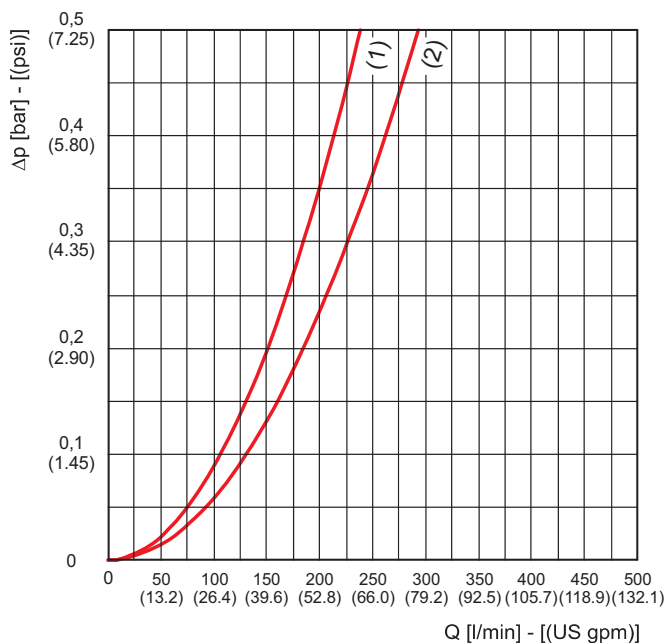

FG010

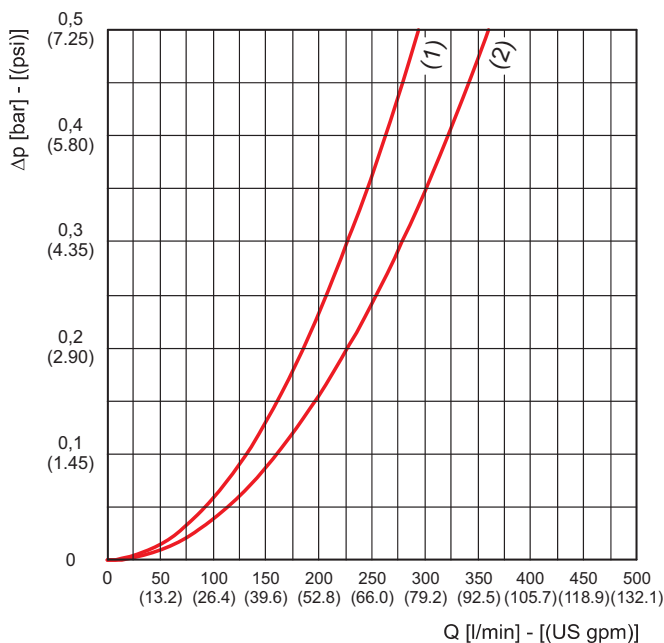

FG025

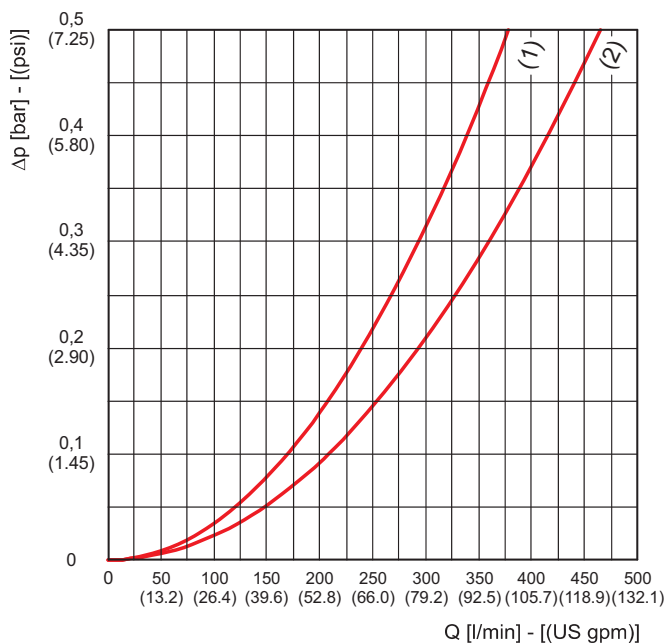

01/07.2010

PRESSURE DROP CURVES THROUGH THE ELEMENT HEK02-30

The curves are obtained in the following conditions:
 Mineral oil type SAE 10
 Kinematic viscosity 120 SSU (30 cSt)
 Density 7.29 lb/gal (0,856 kg/dm³).

- (1) HEK02-30.195
- (2) HEK02-30.239

RP010

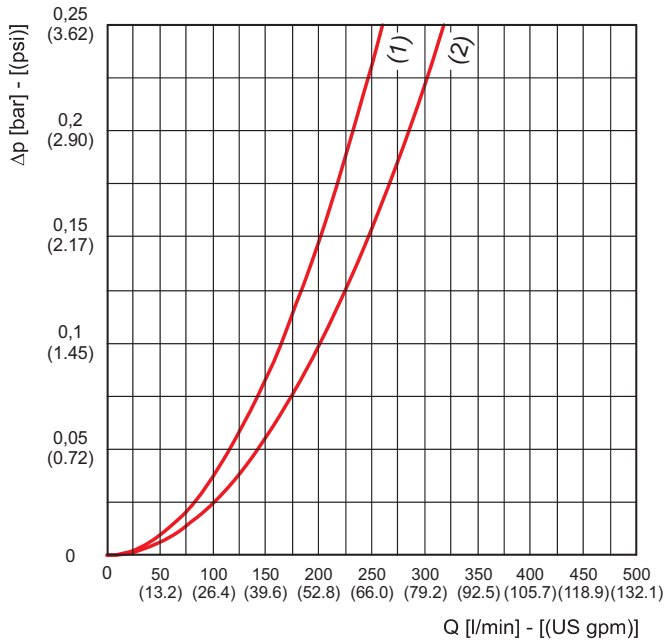

RP025

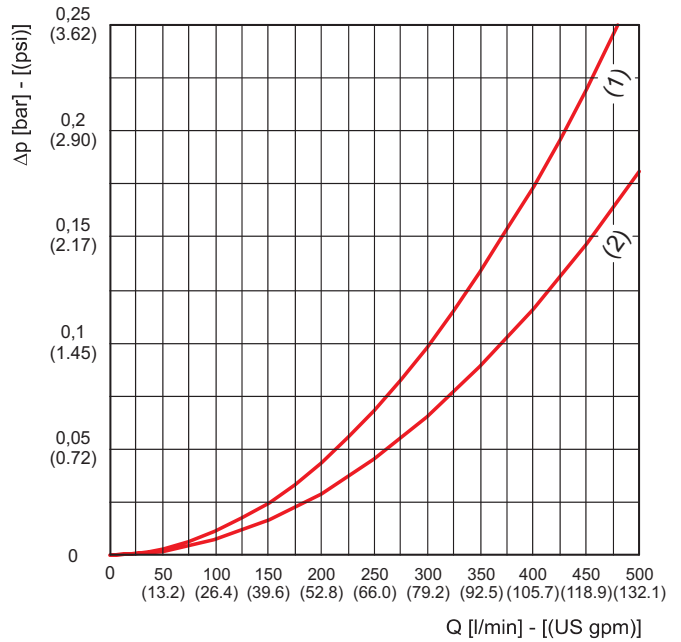

01/07.2010

PRESSURE DROP CURVES THROUGH THE ELEMENT HEK02-30

The curves are obtained in the following conditions:

Mineral oil type SAE 10

Kinematic viscosity 120 SSU (30 cSt)

Density 7.29 lb/gal (0,856 kg/dm³).

(1) HEK02-30.195

(2) HEK02-30.239

MI025

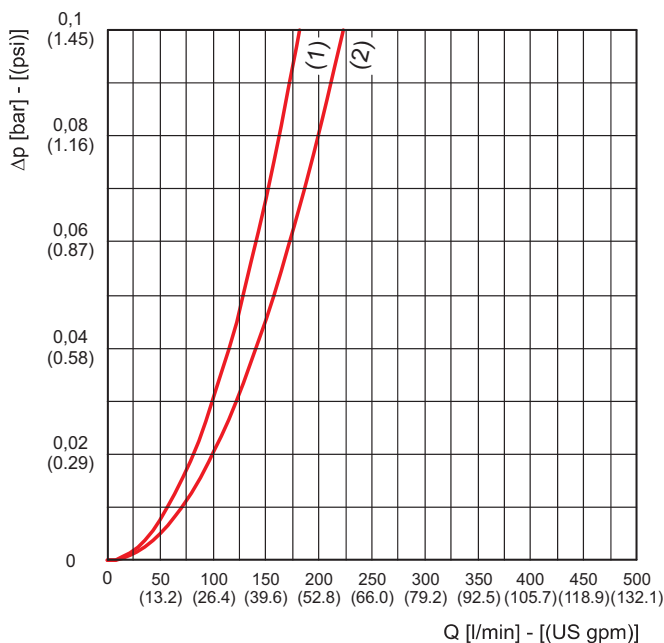

MI060

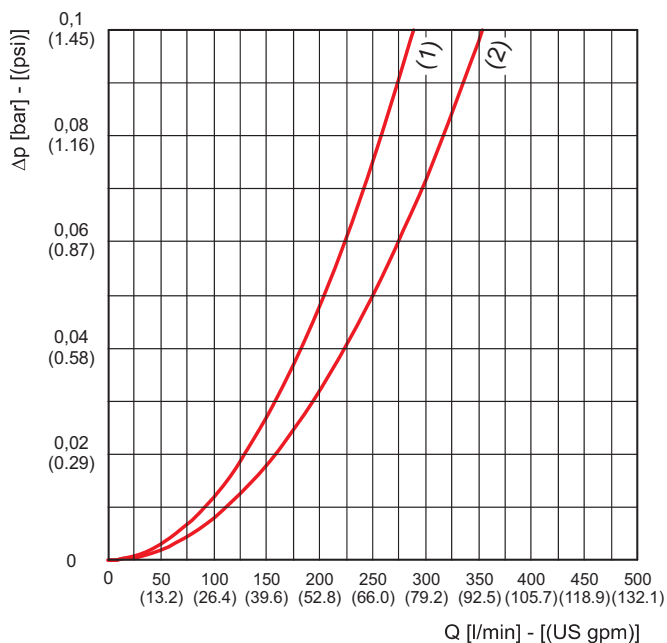

MS090

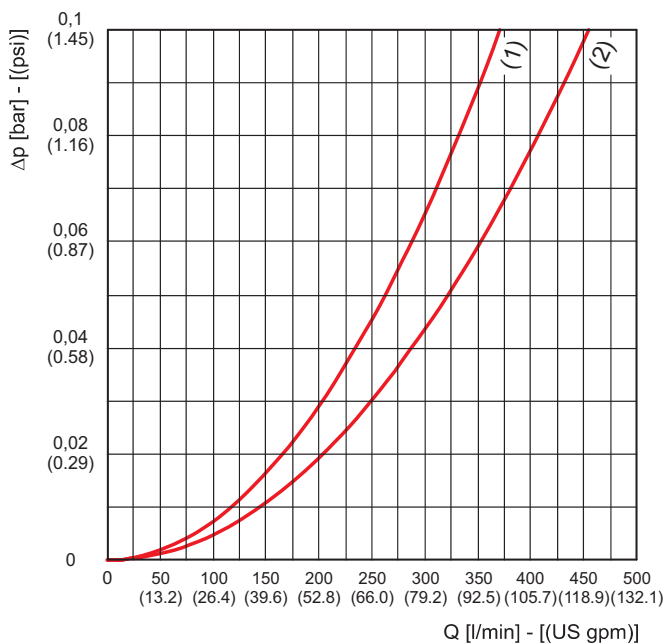

MI125

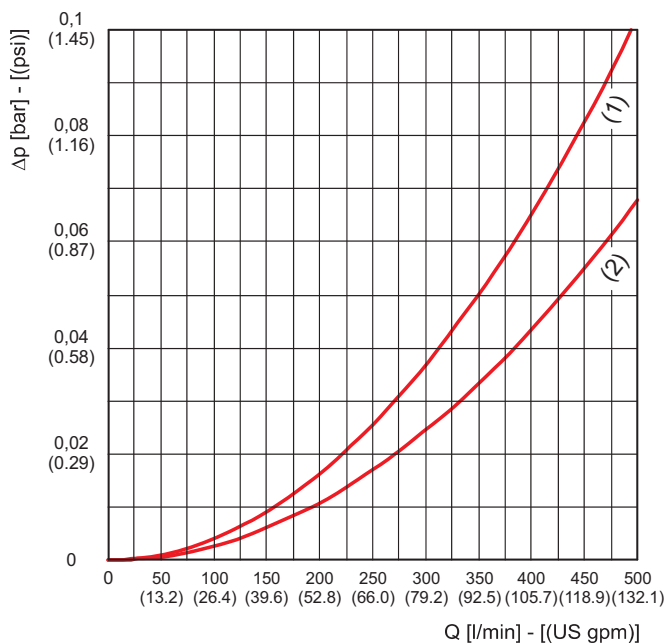

01/07.2010

PRESSURE DROP CURVES THROUGH THE ELEMENT HEK02-40

The curves are obtained in the following conditions:
 Mineral oil type SAE 10
 Kinematic viscosity 120 SSU (30 cSt)
 Density 7.29 lb/gal (0,856 kg/dm³).

- | | |
|------------------|------------------|
| (1) HEK02-40.122 | (4) HEK02-40.239 |
| (2) HEK02-40.194 | (5) HEK02-40.390 |
| (3) HEK02-40.195 | (6) HEK02-40.512 |

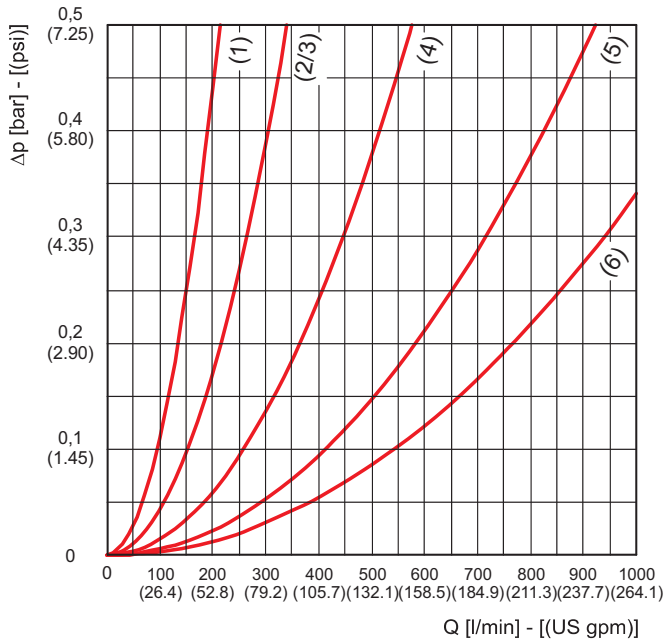
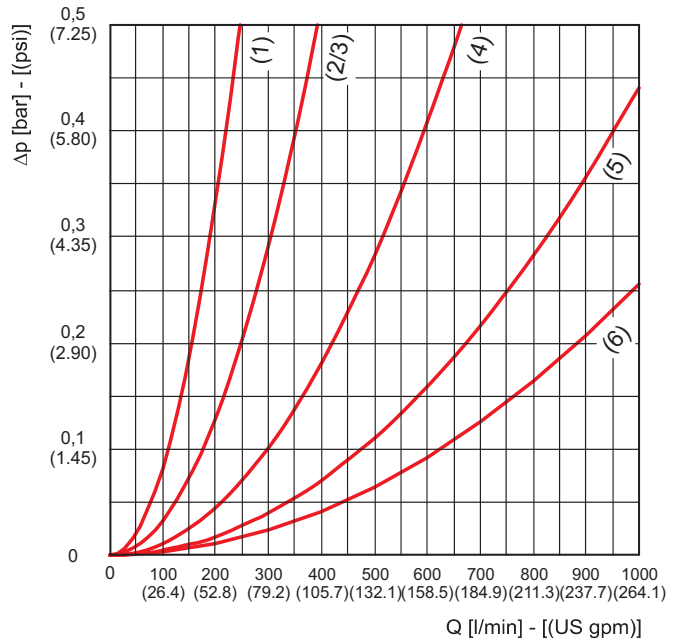
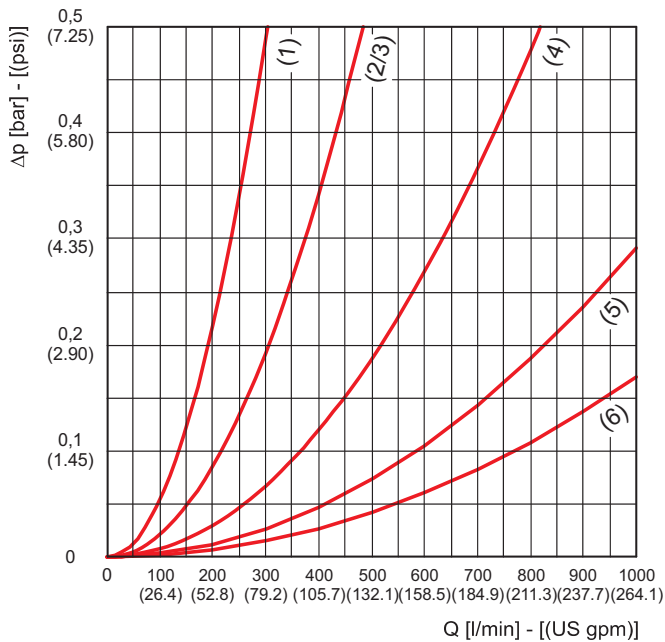
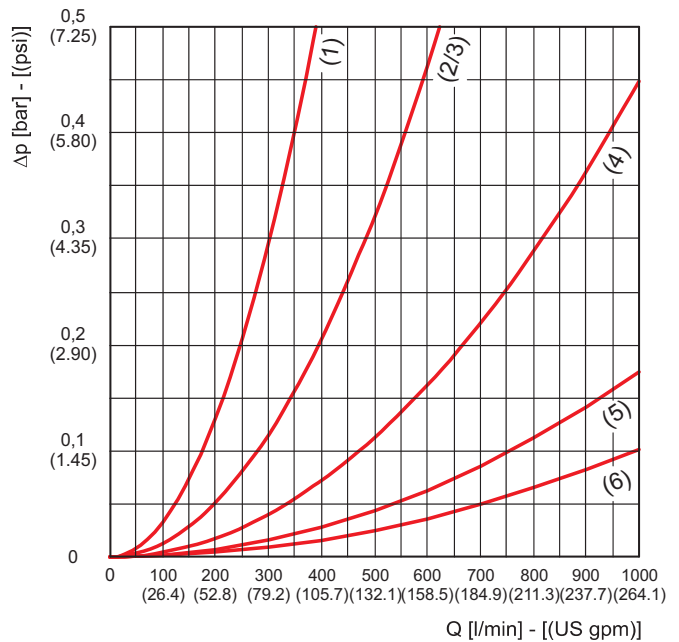
FG003

FG006

FG010

FG025

01/07.2010

PRESSURE DROP CURVES THROUGH THE ELEMENT HEK02-40

The curves are obtained in the following conditions:
 Mineral oil type SAE 10
 Kinematic viscosity 120 SSU (30 cSt)
 Density 7.29 lb/gal (0,856 kg/dm³).

- (1) HEK02-40.122
- (2) HEK02-40.194
- (3) HEK02-40.195
- (4) HEK02-40.239
- (5) HEK02-40.390
- (6) HEK02-40.512

RP010

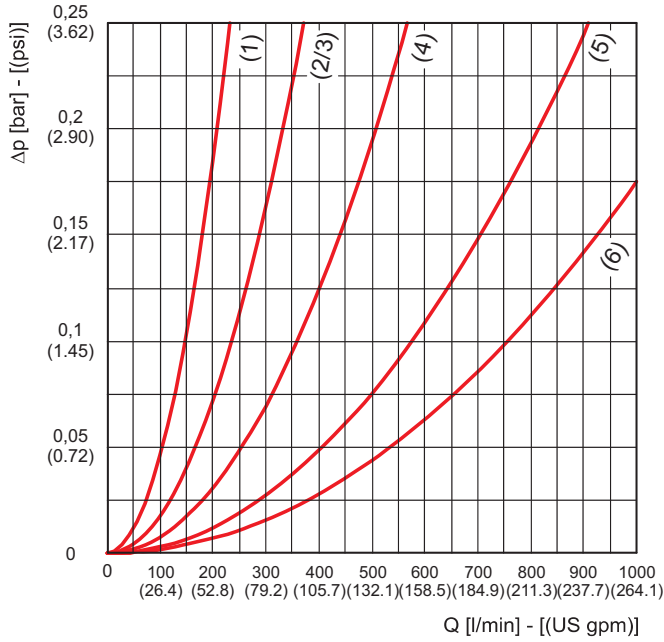

RP025

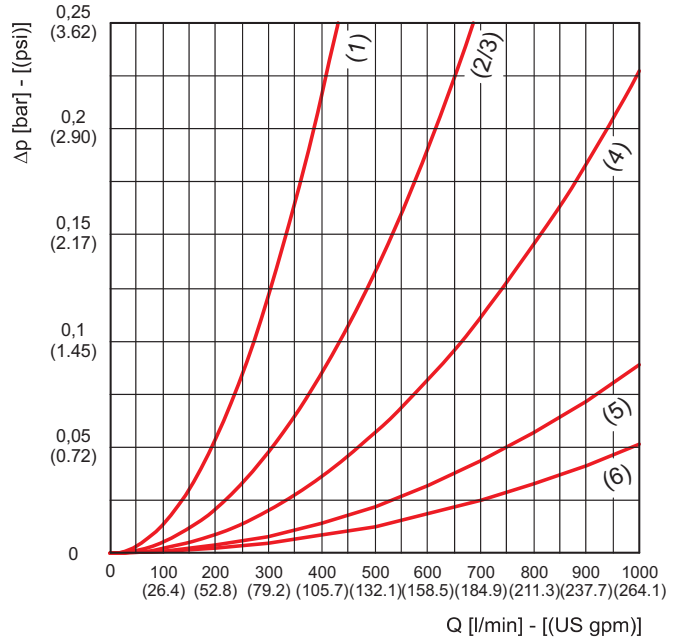

01/07.2010

PRESSURE DROP CURVES THROUGH THE ELEMENT HEK02-40

The curves are obtained in the following conditions:
 Mineral oil type SAE 10
 Kinematic viscosity 120 SSU (30 cSt)
 Density 7.29 lb/gal (0,856 kg/dm³).

- (1) HEK02-40.122
- (2) HEK02-40.194
- (3) HEK02-40.195
- (4) HEK02-40.239
- (5) HEK02-40.390
- (6) HEK02-40.512

MI025

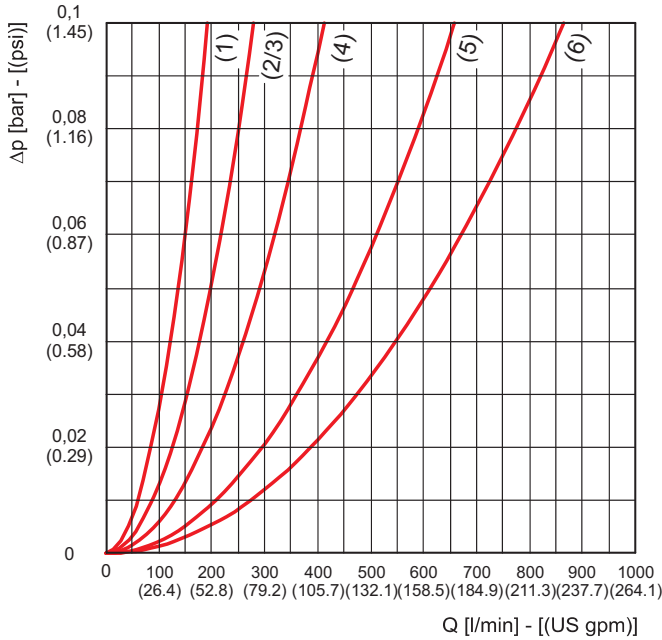

MI060

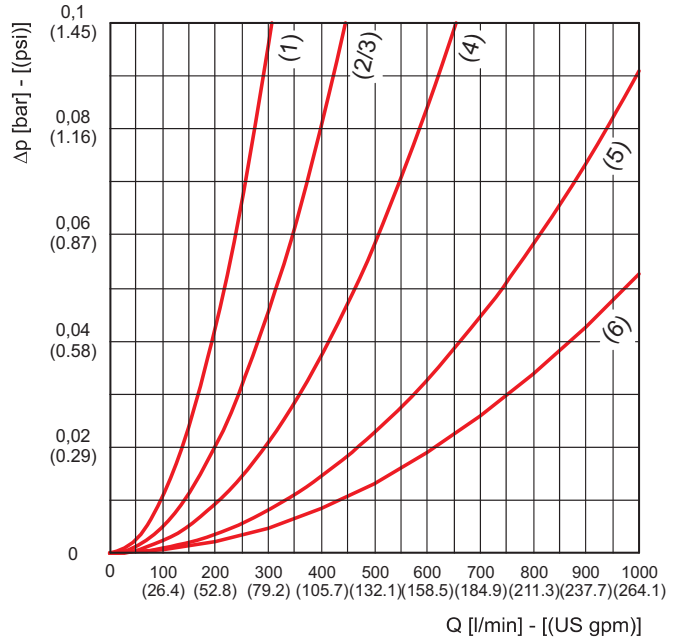

MS090

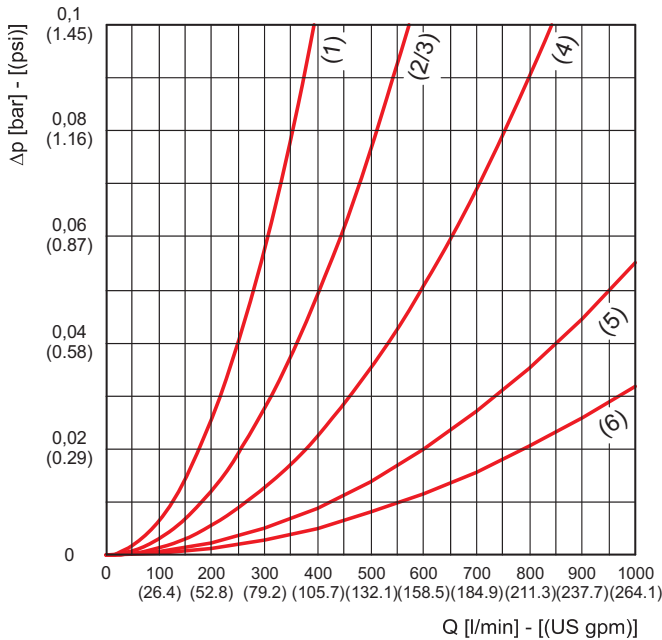

MI125

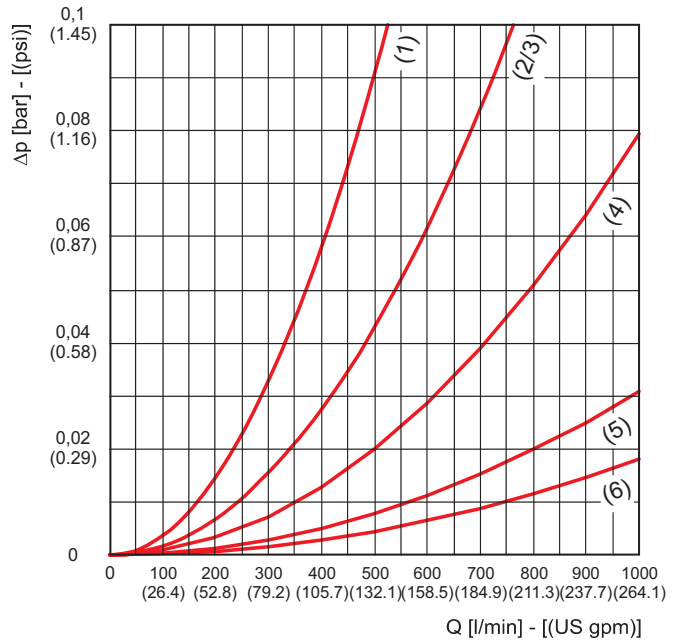

01/07.2010

FLOWS - FILTERS WITH SINGLE INLET PORT

Filter type	Inlet port			Degree of filtration					
				FG003	FG006	FG010	FG025	RP/SP010	RP/SP025
	GAS (BSPP)	NPT	SAE J514b	Flow Δp= 5.8 psi (0,4 bar) (values referred to standard filtering surfaces)					
			US gpm (l/min)						
HF 502-10.060	G 3/8	3/8 NPT	9/16-18 UNF-2B	4.0 (15)	4.0 (15)	6.6 (25)	6.6 (25)	6.6 (25)	9.2 (35)
	G 1/2	1/2 NPT	3/4-16 UNF-2B	4.0 (15)	4.0 (15)	6.6 (25)	6.6 (25)	6.6 (25)	11.9 (45)
	G 3/4	3/4 NPT	1 1/16-12 UNF-2B	4.0 (15)	4.0 (15)	6.6 (25)	7.9 (30)	6.6 (25)	11.9 (45)
HF 502-10.129	G 3/8	3/8 NPT	9/16-18 UNF-2B	7.9 (30)	9.2 (35)	9.2 (35)	11.9 (45)	11.9 (45)	13.2 (50)
	G 1/2	1/2 NPT	3/4-16 UNF-2B	9.2 (35)	9.2 (35)	11.9 (45)	13.2 (50)	11.9 (45)	15.9 (60)
	G 3/4	3/4 NPT	1 1/16-12 UNF-2B	9.2 (35)	9.2 (35)	11.9 (45)	14.5 (55)	13.2 (50)	18.5 (70)
HF 502-20.077	G 1/2	1/2 NPT	3/4-16 UNF-2B	9.2 (35)	9.2 (35)	11.9 (45)	13.2 (50)	13.2 (50)	17.2 (65)
	G 3/4	3/4 NPT	1 1/16-12 UNF-2B	9.2 (35)	9.2 (35)	11.9 (45)	14.5 (55)	14.5 (55)	19.8 (75)
	G 1	1 NPT	1 5/16-12 UNF-2B	9.2 (35)	9.2 (35)	11.9 (45)	14.5 (55)	14.5 (55)	22.5 (85)
HF 502-20.122	G 1 1/4	1 1/4 NPT	1 5/8-12 UNF-2B	9.2 (35)	9.2 (35)	11.9 (45)	14.5 (55)	14.5 (55)	22.5 (85)
	G 1/2	1/2 NPT	3/4-16 UNF-2B	11.9 (45)	13.2 (50)	14.5 (55)	17.2 (65)	17.2 (65)	19.8 (75)
	G 3/4	3/4 NPT	1 1/16-12 UNF-2B	11.9 (45)	14.5 (55)	17.2 (65)	19.8 (75)	19.8 (75)	25.1 (95)
HF 502-20.201	G 1	1 NPT	1 5/16-12 UNF-2B	13.2 (50)	14.5 (55)	17.2 (65)	19.8 (75)	19.8 (75)	26.4 (100)
	G 1 1/4	1 1/4 NPT	1 5/8-12 UNF-2B	13.2 (50)	14.5 (55)	17.2 (65)	21.1 (80)	19.8 (75)	27.7 (105)
	G 1/2	1/2 NPT	3/4-16 UNF-2B	17.2 (65)	17.2 (65)	19.8 (75)	22.5 (85)	21.1 (80)	23.8 (90)
HF 502-20.280	G 3/4	3/4 NPT	1 1/16-12 UNF-2B	18.5 (70)	19.8 (75)	23.8 (90)	27.7 (105)	26.4 (100)	33.0 (125)
	G 1	1 NPT	1 5/16-12 UNF-2B	19.8 (75)	22.5 (85)	25.1 (95)	30.4 (115)	30.4 (115)	38.3 (145)
	G 1 1/4	1 1/4 NPT	1 5/8-12 UNF-2B	19.8 (75)	22.5 (85)	26.4 (100)	31.7 (120)	30.4 (115)	42.3 (160)
HF 502-30.195 HF 508-30.195	G 1/2	1/2 NPT	3/4-16 UNF-2B	19.8 (75)	19.8 (75)	22.5 (85)	22.5 (85)	22.5 (85)	25.1 (95)
	G 3/4	3/4 NPT	1 1/16-12 UNF-2B	22.5 (85)	25.1 (95)	27.7 (105)	30.4 (115)	30.4 (115)	34.3 (130)
	G 1	1 NPT	1 5/16-12 UNF-2B	25.1 (95)	27.7 (105)	31.7 (120)	35.7 (135)	35.7 (135)	40.9 (155)
HF 502-30.239 HF 508-30.239	G 1 1/4	1 1/4 NPT	1 5/8-12 UNF-2B	26.4 (100)	29.1 (110)	33.0 (125)	38.3 (145)	38.3 (145)	46.2 (175)
	G 1	1 NPT	1 5/16-12 UNF-2B	39.6 (150)	40.9 (155)	44.9 (170)	50.2 (190)	50.2 (190)	55.5 (210)
	G 1 1/4	1 1/4 NPT	1 5/8-12 UNF-2B	40.9 (155)	44.9 (170)	50.2 (190)	58.1 (220)	58.1 (220)	71.3 (270)
HF 502-40.122 HF 508-40.122	G 1 1/2	1 1/2 NPT	1 7/8-12 UNF-2B	42.3 (160)	46.2 (175)	55.5 (210)	60.8 (230)	60.8 (230)	74.0 (280)
	G 1	1 NPT	1 5/16-12 UNF-2B	42.3 (160)	44.9 (170)	50.2 (190)	52.8 (200)	52.8 (200)	58.1 (220)
	G 1 1/4	1 1/4 NPT	1 5/8-12 UNF-2B	47.5 (180)	50.2 (190)	55.5 (210)	63.4 (240)	60.8 (230)	71.3 (270)
HF 502-40.194 HF 508-40.194	G 1 1/2	1 1/2 NPT	1 7/8-12 UNF-2B	50.2 (190)	52.8 (200)	60.8 (230)	66.0 (250)	66.0 (250)	76.6 (290)
	G 1 1/2	1 1/2 NPT	1 7/8-12 UNF-2B	46.2 (175)	51.5 (195)	60.8 (230)	72.6 (275)	64.7 (245)	89.8 (340)
	G 2	2 NPT	2 1/2-12 UNF-2B	47.5 (180)	54.1 (205)	63.4 (240)	76.6 (290)	68.7 (260)	100.4 (380)
HF 502-40.195 HF 508-40.195	G 1 1/2	1 1/2 NPT	1 7/8-12 UNF-2B	66.0 (250)	72.6 (275)	81.9 (310)	91.1 (345)	84.5 (320)	103.0 (390)
	G 2	2 NPT	2 1/2-12 UNF-2B	70.0 (265)	76.6 (290)	88.5 (335)	100.4 (380)	92.5 (350)	118.9 (450)
	G 1 1/2	1 1/2 NPT	1 7/8-12 UNF-2B	68.7 (260)	76.6 (290)	87.2 (330)	97.7 (370)	89.8 (340)	113.6 (430)
HF 502-40.239 HF 508-40.239	G 2	2 NPT	2 1/2-12 UNF-2B	72.6 (275)	81.9 (310)	95.1 (360)	111.0 (420)	100.4 (380)	134.7 (510)
	G 1 1/2	1 1/2 NPT	1 7/8-12 UNF-2B	95.1 (360)	100.4 (380)	108.3 (410)	116.2 (440)	108.3 (410)	124.2 (470)
	G 2	2 NPT	2 1/2-12 UNF-2B	105.7 (400)	114.9 (435)	125.5 (475)	138.7 (525)	126.8 (480)	150.6 (570)
HF 502-40.390 HF 508-40.390	G 1 1/2	1 1/2 NPT	1 7/8-12 UNF-2B	113.6 (430)	116.2 (440)	121.5 (460)	124.2 (470)	121.5 (460)	126.8 (480)
	G 2	2 NPT	2 1/2-12 UNF-2B	132.1 (500)	140.0 (530)	146.6 (555)	153.2 (580)	147.9 (560)	159.8 (605)
	G 1 1/2	1 1/2 NPT	1 7/8-12 UNF-2B	118.9 (450)	121.5 (460)	124.2 (470)	126.8 (480)	124.2 (470)	129.4 (490)
HF 502-40.512 HF 508-40.512	G 2	2 NPT	2 1/2-12 UNF-2B	145.3 (550)	147.9 (560)	153.2 (580)	158.5 (600)	153.2 (580)	163.8 (620)

01/07.2010

FLOWS - FILTERS WITH SINGLE INLET PORT

Filter type	Inlet port			Degree of filtration			
				MI025	MI060	MS090	MI125
	GAS (BSPP)	NPT	SAE J514b	Flow $\Delta p = 5.8 \text{ psi (0,4 bar)}$ (values referred to standard filtering surfaces)			
				US gpm (l/min)			
HF 502-10.060	G 3/8	3/8 NPT	9/16-18 UNF-2B	9.2 (35)	11.9 (45)	11.9 (45)	14.5 (55)
	G 1/2	1/2 NPT	3/4-16 UNF-2B	9.2 (35)	11.9 (45)	14.5 (55)	15.9 (60)
	G 3/4	3/4 NPT	1 1/16-12 UNF-2B	9.2 (35)	13.2 (50)	15.9 (60)	17.2 (65)
HF 502-10.129	G 3/8	3/8 NPT	9/16-18 UNF-2B	11.9 (45)	14.5 (55)	14.5 (55)	14.5 (55)
	G 1/2	1/2 NPT	3/4-16 UNF-2B	14.5 (55)	17.2 (65)	17.2 (65)	18.5 (70)
	G 3/4	3/4 NPT	1 1/16-12 UNF-2B	17.2 (65)	19.8 (75)	21.1 (80)	22.5 (85)
HF 502-20.077	G 1/2	1/2 NPT	3/4-16 UNF-2B	14.5 (55)	18.5 (70)	19.8 (75)	21.1 (80)
	G 3/4	3/4 NPT	1 1/16-12 UNF-2B	17.2 (65)	22.5 (85)	23.8 (90)	25.1 (95)
	G 1	1 NPT	1 5/16-12 UNF-2B	17.2 (65)	22.5 (85)	25.1 (95)	27.7 (105)
HF 502-20.122	G 1 1/4	1 1/4 NPT	1 5/8-12 UNF-2B	17.2 (65)	23.8 (90)	26.4 (100)	29.1 (110)
	G 1/2	1/2 NPT	3/4-16 UNF-2B	17.2 (65)	19.8 (75)	21.1 (80)	22.5 (85)
	G 3/4	3/4 NPT	1 1/16-12 UNF-2B	19.8 (75)	23.8 (90)	25.1 (95)	26.4 (100)
HF 502-20.201	G 1	1 NPT	1 5/16-12 UNF-2B	22.5 (85)	26.4 (100)	27.7 (105)	30.4 (115)
	G 1 1/4	1 1/4 NPT	1 5/8-12 UNF-2B	22.5 (85)	27.7 (105)	29.1 (110)	31.7 (120)
	G 1/2	1/2 NPT	3/4-16 UNF-2B	22.5 (85)	25.1 (95)	25.1 (95)	25.1 (95)
HF 502-20.280	G 3/4	3/4 NPT	1 1/16-12 UNF-2B	27.7 (105)	33.0 (125)	33.0 (125)	35.7 (135)
	G 1	1 NPT	1 5/16-12 UNF-2B	30.4 (115)	38.3 (145)	40.9 (155)	42.3 (160)
	G 1 1/4	1 1/4 NPT	1 5/8-12 UNF-2B	33.0 (125)	40.9 (155)	43.6 (165)	46.2 (175)
HF 502-30.195 HF 508-30.195	G 1/2	1/2 NPT	3/4-16 UNF-2B	23.8 (90)	25.1 (95)	25.1 (95)	25.1 (95)
	G 3/4	3/4 NPT	1 1/16-12 UNF-2B	30.4 (115)	33.0 (125)	34.3 (130)	35.7 (135)
	G 1	1 NPT	1 5/16-12 UNF-2B	35.7 (135)	40.9 (155)	42.3 (160)	43.6 (165)
HF 502-30.239 HF 508-30.239	G 1 1/4	1 1/4 NPT	1 5/8-12 UNF-2B	38.3 (145)	44.9 (170)	47.6 (180)	48.9 (185)
	G 1	1 NPT	1 5/16-12 UNF-2B	50.2 (190)	55.5 (210)	58.1 (220)	60.8 (230)
	G 1 1/4	1 1/4 NPT	1 5/8-12 UNF-2B	60.8 (230)	68.7 (260)	71.3 (270)	74.0 (280)
HF 502-40.122 HF 508-40.122	G 1 1/2	1 1/2 NPT	1 7/8-12 UNF-2B	63.4 (240)	74.0 (280)	76.6 (290)	81.9 (310)
	G 1	1 NPT	1 5/16-12 UNF-2B	55.5 (210)	56.8 (215)	58.1 (220)	60.8 (230)
	G 1 1/4	1 1/4 NPT	1 5/8-12 UNF-2B	66.0 (250)	71.3 (270)	74.0 (280)	76.6 (290)
HF 502-40.194 HF 508-40.194	G 1 1/2	1 1/2 NPT	1 7/8-12 UNF-2B	68.7 (260)	76.6 (290)	79.3 (300)	81.9 (310)
	G 1 1/2	1 1/2 NPT	1 7/8-12 UNF-2B	76.6 (290)	95.1 (360)	101.7 (385)	108.3 (410)
	G 2	2 NPT	2 1/2-12 UNF-2B	81.9 (310)	105.7 (400)	116.2 (440)	124.2 (470)
HF 502-40.195 HF 508-40.195	G 1 1/2	1 1/2 NPT	1 7/8-12 UNF-2B	91.1 (345)	104.3 (395)	108.3 (410)	111.0 (420)
	G 2	2 NPT	2 1/2-12 UNF-2B	101.7 (385)	118.9 (450)	126.8 (480)	132.1 (500)
	G 1 1/2	1 1/2 NPT	1 7/8-12 UNF-2B	97.7 (370)	114.9 (435)	121.5 (460)	124.2 (470)
HF 502-40.239 HF 508-40.239	G 2	2 NPT	2 1/2-12 UNF-2B	111.0 (420)	137.4 (520)	145.3 (550)	153.2 (580)
	G 1 1/2	1 1/2 NPT	1 7/8-12 UNF-2B	112.3 (425)	122.8 (465)	125.5 (475)	128.1 (485)
	G 2	2 NPT	2 1/2-12 UNF-2B	132.1 (500)	150.6 (570)	155.9 (590)	161.1 (610)
HF 502-40.390 HF 508-40.390	G 1 1/2	1 1/2 NPT	1 7/8-12 UNF-2B	122.8 (465)	126.8 (480)	129.4 (490)	130.8 (495)
	G 2	2 NPT	2 1/2-12 UNF-2B	150.6 (570)	159.8 (605)	162.5 (615)	163.8 (620)
	G 1 1/2	1 1/2 NPT	1 7/8-12 UNF-2B	126.8 (480)	128.1 (485)	129.4 (490)	130.8 (495)
HF 502-40.512 HF 508-40.512	G 2	2 NPT	2 1/2-12 UNF-2B	155.9 (590)	162.5 (615)	163.8 (620)	166.4 (630)

01/07-2010

FLOWS - FILTERS WITH DOUBLE INLET PORTS

Filter type	Inlet ports				Degree of filtration					
					FG003	FG006	FG010	FG025	RP010	RP025
	GAS (BSPP)	NPT	SAE J514b	SAE 3000 Nom. dim.	Flow Δp= 5.8 psi (0,4 bar) (values referred to standard filtering surfaces)					
					US gpm (l/min)					
HF 508-30.195	G 1 1/4	1 1/4 NPT	1 5/8-12 UNF-2B	1 1/4	44.9	50.2	60.8	71.3	68.7	92.5
	G 1 1/4	1 1/4 NPT	1 5/8-12 UNF-2B	1 1/4	(170)	(190)	(230)	(270)	(260)	(350)
	G 1 1/4	1 1/4 NPT	1 5/8-12 UNF-2B	1 1/4	44.9	50.2	60.8	71.3	71.3	92.5
	G 1 1/2	1 1/2 NPT	1 7/8-12 UNF-2B	1 1/2	(170)	(190)	(230)	(270)	(270)	(350)
	G 1 1/2	1 1/2 NPT	1 7/8-12 UNF-2B	1 1/2	44.9	50.2	60.8	71.3	71.3	97.7
	G 1 1/2	1 1/2 NPT	1 7/8-12 UNF-2B	1 1/2	(170)	(190)	(230)	(270)	(270)	(370)
HF 508-30.239	G 1 1/4	1 1/4 NPT	1 5/8-12 UNF-2B	1 1/4	52.8	58.1	66.0	76.6	76.6	97.7
	G 1 1/4	1 1/4 NPT	1 5/8-12 UNF-2B	1 1/4	(200)	(220)	(250)	(290)	(290)	(370)
	G 1 1/4	1 1/4 NPT	1 5/8-12 UNF-2B	1 1/4	52.8	60.8	68.7	79.2	76.6	100.4
	G 1 1/2	1 1/2 NPT	1 7/8-12 UNF-2B	1 1/2	(200)	(230)	(260)	(300)	(290)	(380)
	G 1 1/2	1 1/2 NPT	1 7/8-12 UNF-2B	1 1/2	55.5	60.8	71.3	81.9	81.9	103.0
	G 1 1/2	1 1/2 NPT	1 7/8-12 UNF-2B	1 1/2	(210)	(230)	(270)	(310)	(310)	(390)
HF 508-40.122	G 1 1/2	1 1/2 NPT	1 7/8-12 UNF-2B	1 1/2	50.2	55.5	66.0	81.9	71.3	108.3
	G 1 1/2	1 1/2 NPT	1 7/8-12 UNF-2B	1 1/2	(190)	(210)	(250)	(310)	(270)	(410)
	G 1 1/2	1 1/2 NPT	1 7/8-12 UNF-2B	1 1/2	50.2	55.5	66.0	81.9	71.3	113.6
	G 2	2 NPT	2 1/2-12 UNF-2B	2	(190)	(210)	(250)	(310)	(270)	(430)
	G 2	2 NPT	2 1/2-12 UNF-2B	2	50.2	55.5	66.0	83.2	71.3	116.2
	G 2	2 NPT	2 1/2-12 UNF-2B	2	(190)	(210)	(250)	(315)	(270)	(440)
HF 508-40.194	-	-	-	2	50.2	55.5	66.0	84.5	71.3	118.9
	-	-	-	2 1/2	(190)	(210)	(250)	(320)	(270)	(450)
	G 1 1/2	1 1/2 NPT	1 7/8-12 UNF-2B	1 1/2	71.3	81.9	92.5	111.0	97.7	134.7
	G 1 1/2	1 1/2 NPT	1 7/8-12 UNF-2B	1 1/2	(270)	(310)	(350)	(420)	(370)	(510)
	G 1 1/2	1 1/2 NPT	1 7/8-12 UNF-2B	1 1/2	74.0	81.9	97.7	113.6	103.0	140.0
	G 2	2 NPT	2 1/2-12 UNF-2B	2	(280)	(310)	(370)	(430)	(390)	(530)
HF 508-40.195	G 2	2 NPT	2 1/2-12 UNF-2B	2	76.6	84.5	97.7	118.9	105.7	150.6
	G 2	2 NPT	2 1/2-12 UNF-2B	2	(290)	(320)	(370)	(450)	(400)	(570)
	-	-	-	2	76.6	84.5	100.4	118.9	105.7	151.9
	-	-	-	2 1/2	(290)	(320)	(380)	(450)	(400)	(575)
	G 1 1/2	1 1/2 NPT	1 7/8-12 UNF-2B	1 1/2	74.0	81.9	97.7	116.2	103.0	145.3
	G 1 1/2	1 1/2 NPT	1 7/8-12 UNF-2B	1 1/2	(280)	(310)	(370)	(440)	(390)	(550)
HF 508-40.239	G 1 1/2	1 1/2 NPT	1 7/8-12 UNF-2B	1 1/2	76.6	84.5	100.4	118.9	108.3	153.2
	G 2	2 NPT	2 1/2-12 UNF-2B	2	(290)	(320)	(380)	(450)	(410)	(580)
	G 2	2 NPT	2 1/2-12 UNF-2B	2	76.6	87.2	103.0	124.2	111.0	163.8
	G 2	2 NPT	2 1/2-12 UNF-2B	2	(290)	(330)	(390)	(470)	(420)	(620)
	-	-	-	2	76.6	87.2	105.7	129.4	113.6	174.4
	-	-	-	2 1/2	(290)	(330)	(400)	(490)	(430)	(660)
HF 508-40.390	G 1 1/2	1 1/2 NPT	1 7/8-12 UNF-2B	1 1/2	108.3	118.9	134.7	147.9	134.7	163.8
	G 1 1/2	1 1/2 NPT	1 7/8-12 UNF-2B	1 1/2	(410)	(450)	(510)	(560)	(510)	(620)
	G 1 1/2	1 1/2 NPT	1 7/8-12 UNF-2B	1 1/2	113.6	124.2	140.0	158.5	140.0	179.6
	G 2	2 NPT	2 1/2-12 UNF-2B	2	(430)	(470)	(530)	(600)	(530)	(680)
	G 2	2 NPT	2 1/2-12 UNF-2B	2	118.9	132.0	146.6	171.7	147.9	195.5
	G 2	2 NPT	2 1/2-12 UNF-2B	2	(450)	(500)	(555)	(650)	(560)	(740)
HF 508-40.512	-	-	-	2	121.5	134.7	154.5	179.6	155.9	211.3
	-	-	-	2 1/2	(460)	(510)	(585)	(680)	(590)	(800)
	G 1 1/2	1 1/2 NPT	1 7/8-12 UNF-2B	1 1/2	142.7	150.6	158.5	169.1	158.5	178.0
	G 1 1/2	1 1/2 NPT	1 7/8-12 UNF-2B	1 1/2	(540)	(570)	(600)	(640)	(600)	(670)
	G 1 1/2	1 1/2 NPT	1 7/8-12 UNF-2B	1 1/2	150.6	158.5	171.7	184.9	171.7	195.5
	G 2	2 NPT	2 1/2-12 UNF-2B	2	(570)	(600)	(650)	(700)	(650)	(740)
HF 508-40.512	G 2	2 NPT	2 1/2-12 UNF-2B	2	161.1	171.7	187.6	203.4	187.6	216.6
	G 2	2 NPT	2 1/2-12 UNF-2B	2	(610)	(650)	(710)	(770)	(710)	(820)
	-	-	-	2	169.1	177.0	200.8	221.9	200.8	237.7
	-	-	-	2 1/2	(640)	(670)	(760)	(840)	(760)	(900)
	G 1 1/2	1 1/2 NPT	1 7/8-12 UNF-2B	1 1/2	155.9	161.1	166.4	174.4	169.1	179.6
	G 1 1/2	1 1/2 NPT	1 7/8-12 UNF-2B	1 1/2	(590)	(610)	(630)	(660)	(640)	(680)
HF 508-40.512	G 1 1/2	1 1/2 NPT	1 7/8-12 UNF-2B	1 1/2	166.4	174.4	184.9	190.2	184.9	198.1
	G 2	2 NPT	2 1/2-12 UNF-2B	2	(630)	(660)	(700)	(720)	(700)	(750)
	G 2	2 NPT	2 1/2-12 UNF-2B	2	182.3	190.2	203.4	216.6	203.4	224.5
	G 2	2 NPT	2 1/2-12 UNF-2B	2	(690)	(720)	(770)	(820)	(770)	(850)
	-	-	-	2	192.8	206.1	221.9	235.1	221.9	248.3
	-	-	-	2 1/2	(730)	(780)	(840)	(890)	(840)	(940)

01/07.2010

FLOWS - FILTERS WITH DOUBLE INLET PORTS

Filter type	Inlet ports				Degree of filtration			
					MI025	MI060	MS090	MI125
	GAS (BSPP)	NPT	SAE J514b	SAE 3000 Nom. dim.	Flow Δp= 5.8 psi (0,4 bar) (values referred to standard filtering surfaces)			
					US gpm (l/min)			
HF 508-30.195	G 1 1/4	1 1/4 NPT	1 5/8-12 UNF-2B	1 1/4	71.3	89.8	97.7	103.0
	G 1 1/4	1 1/4 NPT	1 5/8-12 UNF-2B	1 1/4	(270)	(340)	(370)	(390)
	G 1 1/4	1 1/4 NPT	1 5/8-12 UNF-2B	1 1/4	74.0	92.5	100.4	105.7
	G 1 1/2	1 1/2 NPT	1 7/8-12 UNF-2B	1 1/2	(280)	(350)	(380)	(400)
	G 1 1/2	1 1/2 NPT	1 7/8-12 UNF-2B	1 1/2	76.6	95.1	103.0	111.0
	G 1 1/2	1 1/2 NPT	1 7/8-12 UNF-2B	1 1/2	(290)	(360)	(390)	(420)
HF 508-30.239	G 1 1/4	1 1/4 NPT	1 5/8-12 UNF-2B	1 1/4	81.9	95.1	100.4	104.3
	G 1 1/4	1 1/4 NPT	1 5/8-12 UNF-2B	1 1/4	(310)	(360)	(380)	(395)
	G 1 1/4	1 1/4 NPT	1 5/8-12 UNF-2B	1 1/4	81.9	97.7	103.0	108.3
	G 1 1/2	1 1/2 NPT	1 7/8-12 UNF-2B	1 1/2	(310)	(370)	(390)	(410)
	G 1 1/2	1 1/2 NPT	1 7/8-12 UNF-2B	1 1/2	84.5	103.0	108.3	113.6
	G 1 1/2	1 1/2 NPT	1 7/8-12 UNF-2B	1 1/2	(320)	(390)	(410)	(430)
HF 508-40.122	G 1 1/2	1 1/2 NPT	1 7/8-12 UNF-2B	1 1/2	87.1	116.2	129.4	142.7
	G 1 1/2	1 1/2 NPT	1 7/8-12 UNF-2B	1 1/2	(330)	(440)	(490)	(540)
	G 1 1/2	1 1/2 NPT	1 7/8-12 UNF-2B	1 1/2	88.5	118.9	134.7	150.6
	G 2	2 NPT	2 1/2-12 UNF-2B	2	(335)	(450)	(510)	(570)
	G 2	2 NPT	2 1/2-12 UNF-2B	2	89.8	124.2	142.7	161.1
	G 2	2 NPT	2 1/2-12 UNF-2B	2	(340)	(470)	(540)	(610)
HF 508-40.194	-	-	-	2	92.5	126.8	145.3	163.8
	-	-	-	2 1/2	(350)	(480)	(550)	(620)
	G 1 1/2	1 1/2 NPT	1 7/8-12 UNF-2B	1 1/2	111.0	134.7	145.3	153.2
	G 1 1/2	1 1/2 NPT	1 7/8-12 UNF-2B	1 1/2	(420)	(510)	(550)	(580)
	G 1 1/2	1 1/2 NPT	1 7/8-12 UNF-2B	1 1/2	113.6	142.7	153.2	163.8
	G 2	2 NPT	2 1/2-12 UNF-2B	2	(430)	(540)	(580)	(620)
HF 508-40.195	G 2	2 NPT	2 1/2-12 UNF-2B	2	118.9	150.6	163.8	177.0
	G 2	2 NPT	2 1/2-12 UNF-2B	2	(450)	(570)	(620)	(670)
	-	-	-	2	120.2	153.2	169.1	179.6
	-	-	-	2 1/2	(455)	(580)	(640)	(680)
	G 1 1/2	1 1/2 NPT	1 7/8-12 UNF-2B	1 1/2	116.2	145.3	158.5	169.1
	G 1 1/2	1 1/2 NPT	1 7/8-12 UNF-2B	1 1/2	(440)	(550)	(600)	(640)
HF 508-40.239	G 1 1/2	1 1/2 NPT	1 7/8-12 UNF-2B	1 1/2	118.9	155.9	171.7	184.9
	G 2	2 NPT	2 1/2-12 UNF-2B	2	(450)	(590)	(650)	(700)
	G 2	2 NPT	2 1/2-12 UNF-2B	2	124.2	166.4	184.9	203.4
	G 2	2 NPT	2 1/2-12 UNF-2B	2	(470)	(630)	(700)	(770)
	-	-	-	2	129.4	177.0	198.1	221.9
	-	-	-	2 1/2	(490)	(670)	(750)	(840)
HF 508-40.390	G 1 1/2	1 1/2 NPT	1 7/8-12 UNF-2B	1 1/2	140.0	163.8	171.7	177.0
	G 1 1/2	1 1/2 NPT	1 7/8-12 UNF-2B	1 1/2	(530)	(620)	(650)	(670)
	G 1 1/2	1 1/2 NPT	1 7/8-12 UNF-2B	1 1/2	150.6	177.0	187.6	195.5
	G 2	2 NPT	2 1/2-12 UNF-2B	2	(570)	(670)	(710)	(740)
	G 2	2 NPT	2 1/2-12 UNF-2B	2	161.1	195.5	208.7	219.3
	G 2	2 NPT	2 1/2-12 UNF-2B	2	(610)	(740)	(790)	(830)
HF 508-40.512	-	-	-	2	169.1	211.3	227.2	243.0
	-	-	-	2 1/2	(640)	(800)	(860)	(920)
	G 1 1/2	1 1/2 NPT	1 7/8-12 UNF-2B	1 1/2	163.8	177.0	179.6	182.3
	G 1 1/2	1 1/2 NPT	1 7/8-12 UNF-2B	1 1/2	(620)	(670)	(680)	(690)
	G 1 1/2	1 1/2 NPT	1 7/8-12 UNF-2B	1 1/2	177.0	192.8	198.1	200.8
	G 2	2 NPT	2 1/2-12 UNF-2B	2	(670)	(730)	(750)	(760)
HF 508-40.195	G 2	2 NPT	2 1/2-12 UNF-2B	2	195.5	216.6	224.5	227.2
	G 2	2 NPT	2 1/2-12 UNF-2B	2	(740)	(820)	(850)	(860)
	-	-	-	2	211.3	237.7	248.3	253.6
	-	-	-	2 1/2	(800)	(900)	(940)	(960)
	G 1 1/2	1 1/2 NPT	1 7/8-12 UNF-2B	1 1/2	171.7	179.6	182.3	184.9
	G 1 1/2	1 1/2 NPT	1 7/8-12 UNF-2B	1 1/2	(650)	(680)	(690)	(700)
HF 508-40.195	G 1 1/2	1 1/2 NPT	1 7/8-12 UNF-2B	1 1/2	187.6	198.1	200.1	203.4
	G 2	2 NPT	2 1/2-12 UNF-2B	2	(710)	(750)	(760)	(770)
	G 2	2 NPT	2 1/2-12 UNF-2B	2	208.7	224.5	227.2	232.5
	G 2	2 NPT	2 1/2-12 UNF-2B	2	(790)	(850)	(860)	(880)
	-	-	-	2	227.2	248.3	253.6	264.1
	-	-	-	2 1/2	(860)	(940)	(960)	(1000)

01/07.2010

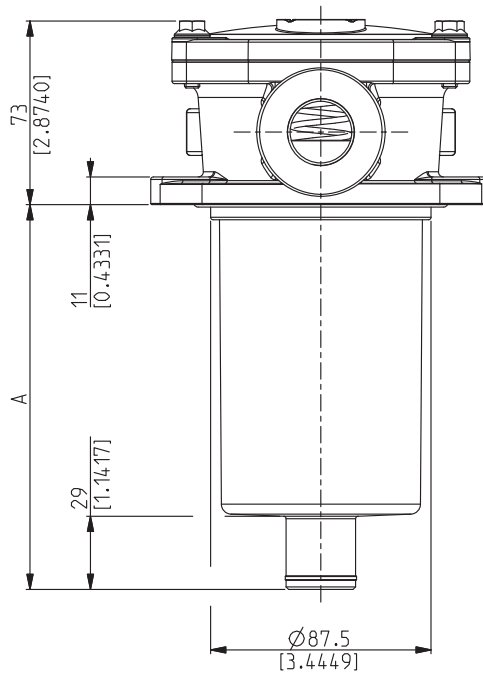
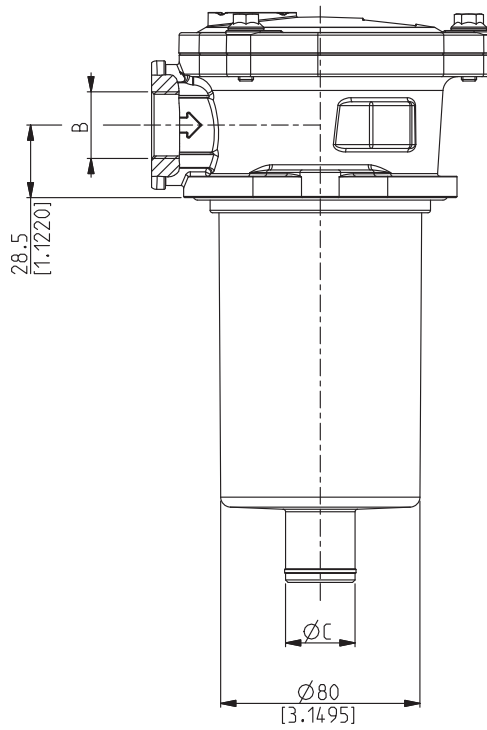
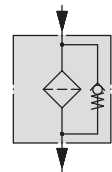
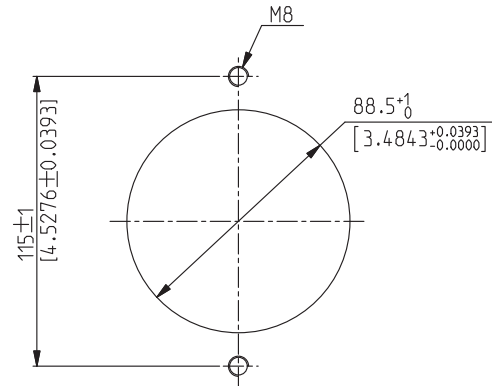
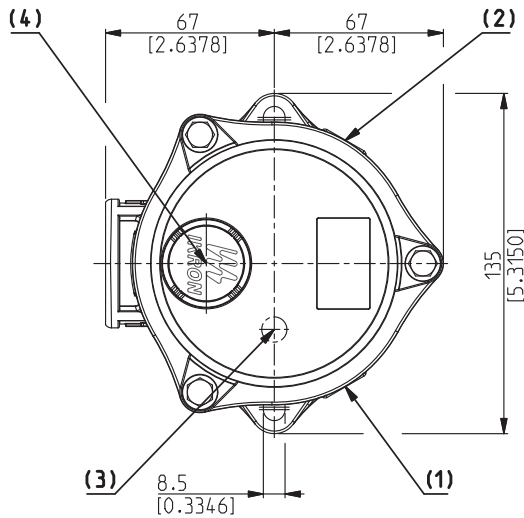
HF502-20 DIMENSIONS

RESERVOIR MOUNTING HOLE DIMENSIONS

ICAT_014_002_HF502

01/07.2010

Filter type	Weight kg(lbs)	A mm(in)	B (GAS-BSPP)		ØC mm(in)	(4)(GAS-BSPP)	(1)(2)(3)(GAS-BSPP)	(4)(GAS-BSPP)
			Standard	On request		Secondary inlet	Indicators	Filler cap
HF 502-20.077	0.96 (2.11)	103 (4.0551)	G 3/4	G 1/2 - G 1 - G 1 1/4	27.5 (1.0826)			
HF 502-20.122	1.07 (2.35)	148 (5.8267)	G 1	G 1/2 - G3/4 - G 1 1/4		G 3/8 G 1/2	G 1/8	
HF 502-20.201	1.23 (2.71)	229 (9.0157)	G 1 1/4	G 1/2 - G 3/4 - G1	40 (1.5747)	G 3/4		G 3/4
HF 502-20.280	1.43 (3.15)	312 (12.2834)						

NPT, metric and SAE UN-UNF threads are available (consult our technical department).

HF502-30 DIMENSIONS

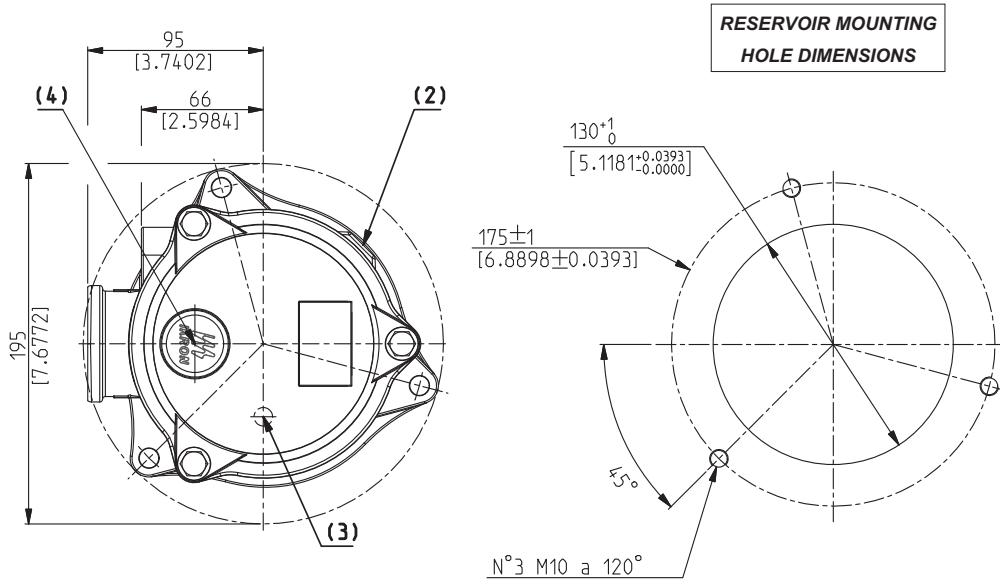
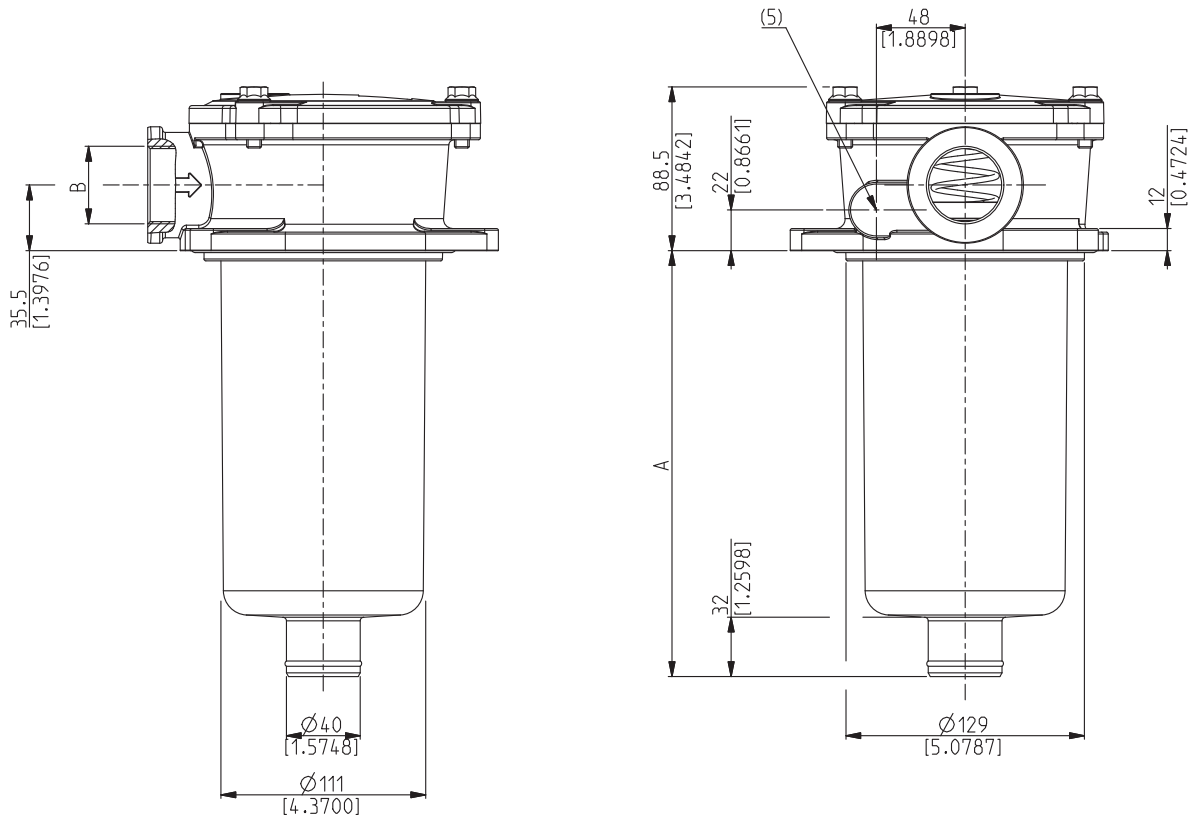

**RESERVOIR MOUNTING
HOLE DIMENSIONS**

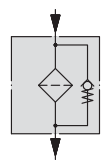

01/07.2010
ICAT_014_003_HF502

Filter type	Weight kg(lbs)	A mm(in)	B (GAS-BSPP)		(4)(5)(GAS-BSPP)	(2)(3)(GAS-BSPP)	(4)(GAS-BSPP)
			Standard	On request	Secondary inlet	Indicators	Filler cap
HF 502-30.195	2,24 (4.93)	230 (9.0550)	G 1 1/4	G 1 - G 1 1/2	G 3/8 Pos.(5) G 1/2 Pos.(4)-(5)	G 1/8	G 3/4
HF 502-30.239	2,46 (5.42)	273 (10.7480)	G 1 1/2	G 1 - G 1 1/4	G 3/4 Pos.(4)		

NPT, metric and SAE UN-UNF threads are available (consult our technical department).

ELEMENTS DIMENSIONS FOR HF 502 / HF 508

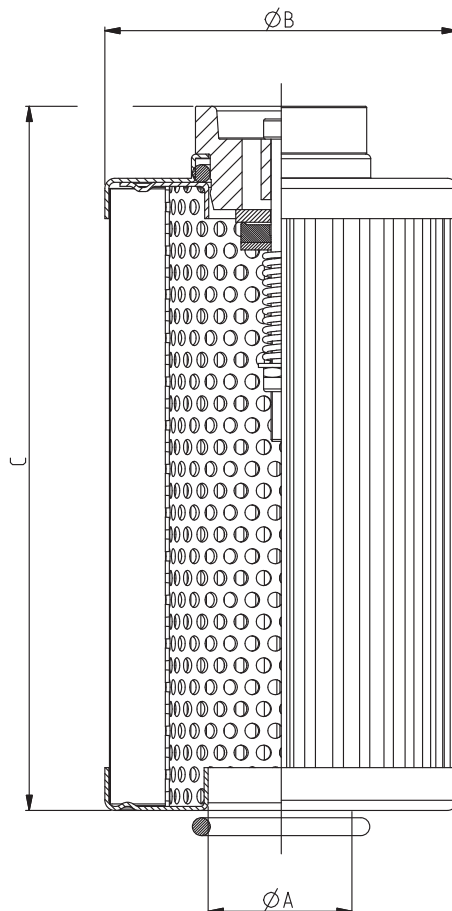

ICAT_014_007_HF502

Element series HEK02-40.239, HEK02-40.390, HEK02-40.512 are only available with (FS) version.

Element type	Ø A	Ø B	C	Filtering surface type	Filtering surface		
	mm(in)	mm(in)			FG	MI / MS	RP / SP
			mm(in)		cm ² (in ²)	cm ² (in ²)	cm ² (in ²)
HEK02-10.060	26	52	75 (2.9527)	AS	346 (53.6301)	227 (35.1850)	400 (62.0001)
HEK02-10.129	(1.0226)	(2.0472)	144 (5.6692)	AS	743 (115.1652)	488 (75.6401)	859 (133.1453)
HEK02-20.077	29		95 (3.7401)	AS	702 (108.8102)	444 (68.8201)	850 (131.7503)
HEK02-20.122	(1.1417)		140 (5.5117)	AS	1113 (172.5153)	615 (95.3251)	1347 (208.7854)
HEK02-20.201	41	70	225 (8.8582)	AS	1680 (260.4005)	929 (143.9953)	2034 (315.2706)
HEK02-20.280	(1.6141)	(2.7558)	304 (11.9684)	AS	2341 (362.8557)	1294 (200.5704)	2834 (439.2709)
HEK02-30.195	41	99	212 (8.3664)	AS	3705 (574.2761)	2048 (317.4406)	4485 (695.1764)
HEK02-30.239	(1.6141)	(3.8976)	255 (10.0393)	AS	4541 (703.8564)	2510 (389.0508)	5497 (852.0367)
HEK04-40.122	52		139 (5.4724)	AS	3821 (592.2562)	2174 (336.3707)	4019 (622.9462)
HEK02-40.194	(2.0472)		212 (8.3464)	AS	6107 (946.5869)	3159 (489.6460)	6423 (995.5670)
HEK02-40.195		130			6107 (946.5869)	3159 (489.6460)	6423 (995.5670)
HEK02-40.239	65	(5.1180)	256 (10.0787)	FS	10325 (1600.3780)	4646 (720.1314)	9809 (1520.3980)
HEK02-40.390	(2.5590)		407 (16.0235)	FS	16536 (2563.0850)	7441 (1153.3570)	15709 (2434.9000)
HEK02-40.512			529 (20.8267)	FS	21709 (3364.9020)	9769 (1514.1980)	20623 (3196.5710)

01/07.2010

INDICATORS

REAR MANOMETER

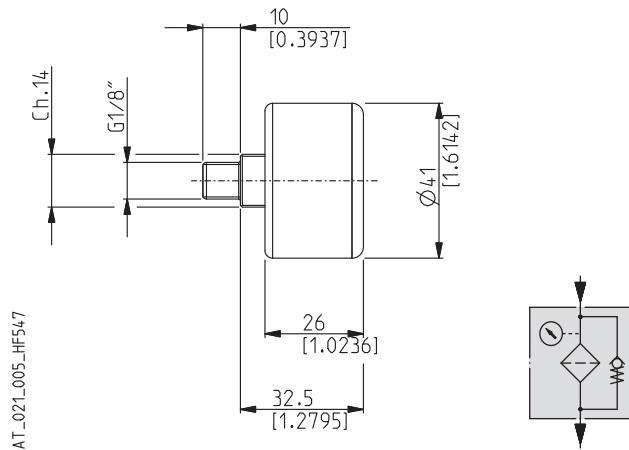
 Code: **M**

ICAT_021_005_HF547

Scale 0 + +145 psi (0 + +10 bar)

RADIAL MANOMETER

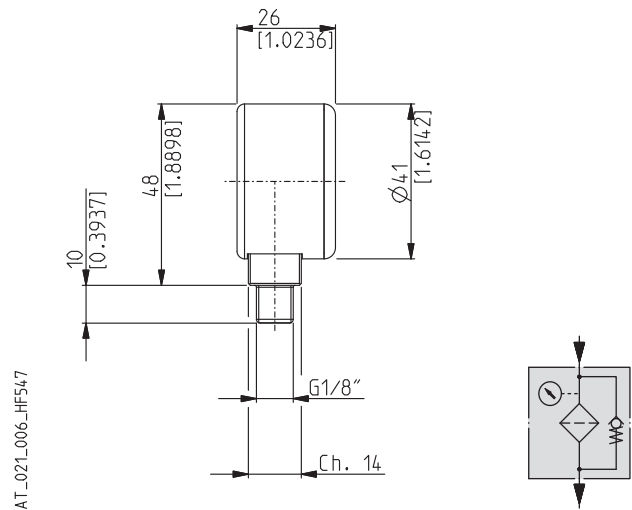
 Code: **N**

ICAT_021_006_HF547

Scale 0 + +145 psi (0 + +10 bar)

VISUAL INDICATOR

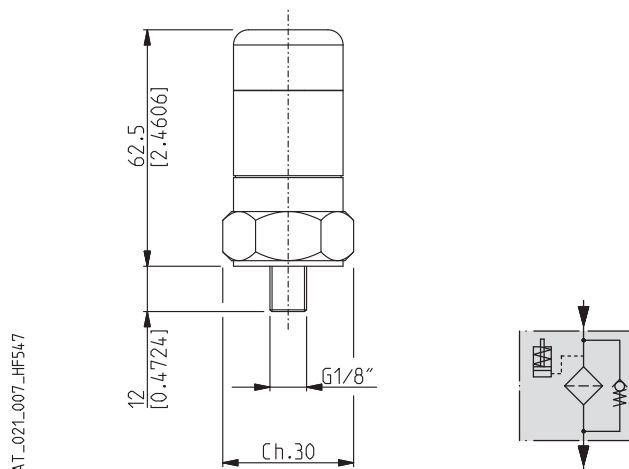
 Code: **P**

ICAT_021_007_HF547

Pressure setting 21.8 psi (1,5 bar)

ELECTRICAL INDICATOR

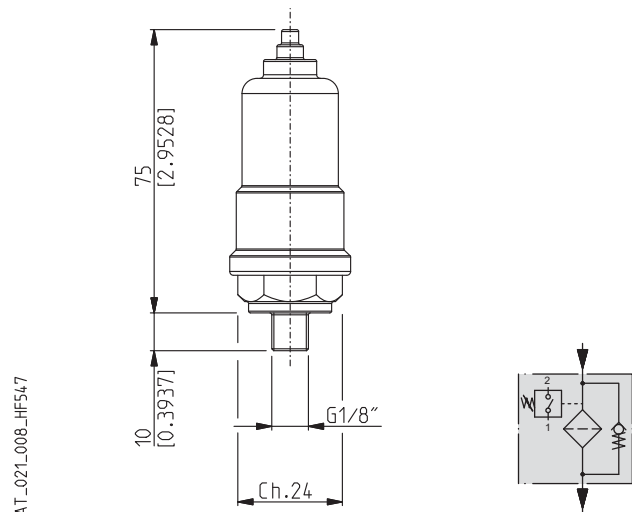
 Code: **S**

ICAT_021_008_HF547

Pressure setting 21.8 psi (1,5 bar)

 Max. working voltage 220 VCA
30 VCC

 Max. working current 0,5 A (resistivity)
0,2 A (inductive)

Protection class IP65

Contacts N.O.contact

01/07.2010

ACCESSORIES

WITH DIFFUSER

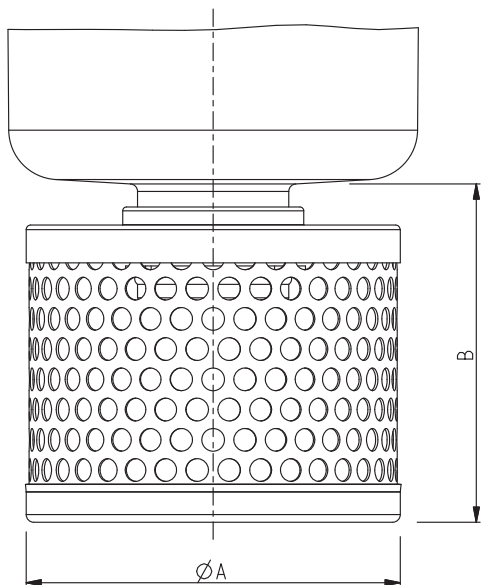

Filter type	A	B
	mm(in)	mm(in)
HF 502-10	52 (2.0472)	50 (1.9684)
HF 502-20	70 (2.7558)	65 (2.5590)
HF 502-30 HF 508-30	99 (3.8976)	90 (3.5432)
HF 502-40 HF 508-40	140 (5.5117)	150 (5.9054)

WITH BOWL EXTENSION

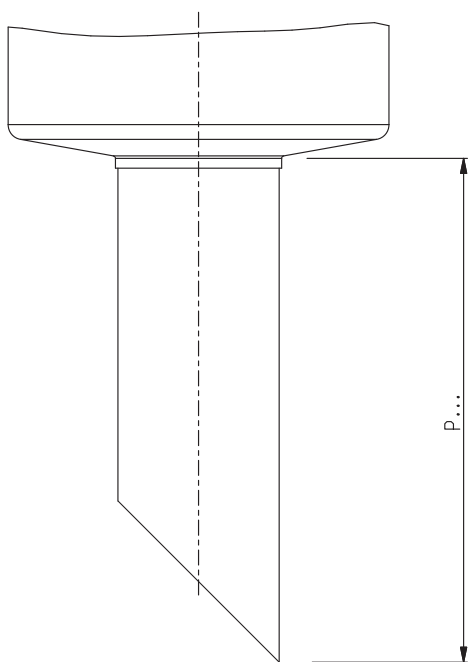

WITH LEVEL DIPSTICK

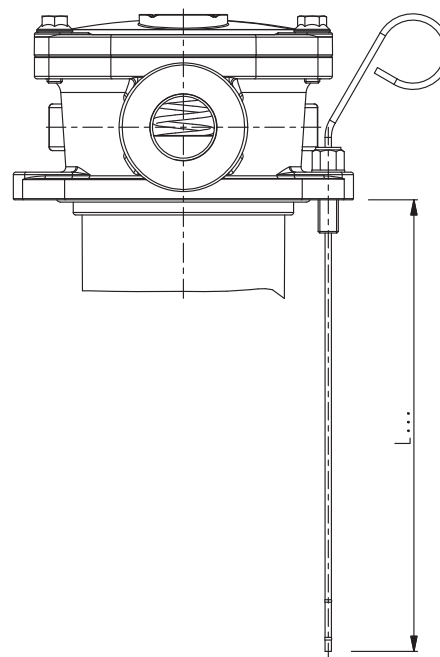

01/07.2010

ICAT_014_008_HF502

INLET PORTS

Filter type	PORTS TYPE					
	Nominal size	Gas BSPP	NPT	SAE ODT	Split SSM (3000 PSI)	Split SSS (3000 PSI)
HF 502-10	3/8"	GC	NC	OA	--	--
	1/2"	GD	ND	OB	--	--
	3/4"	GE	NE	OD	--	--
HF 502-20	1/2"	GD	ND	OB	--	--
	3/4"	GE	NE	OD	--	--
	1"	GF	NF	OF	--	--
HF 502-30	1" 1/4	GG	NG	OG	--	--
	1"	GF	NF	OF	--	--
	1" 1/2	GH	NH	OH	--	--
HF 508-30	1"	GF	NF	OF	--	--
	1" 1/4	GG	NG	OG	MD	SD
	1" 1/2	GH	NH	OH	ME	SE
HF 502-40	1" 1/2	GH	NH	OH	--	--
	2"	GL	NL	OI	--	--
HF 508-40	1" 1/2	GH	NH	OH	ME	SE
	2"	GL	NL	OI	MF	SF
	2" 1/2	-	-	-	MG	SG

GAS THREAD
BSPP

Cylindrical GAS thread (55°) in accordance with UNI - ISO 228

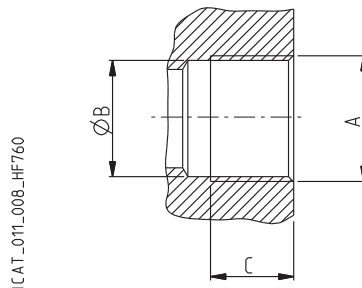

CODE	Nominal size	A	Ø B		C	Nm (lbf in)
			mm (in)	mm (in)		
GC	3/8"	G 3/8	15 (0.5905)	14 (0.5511)	15 ⁺¹ (133 ÷ 142)	
GD	1/2"	G 1/2	19 (0.7480)	17 (0.6692)	20 ⁺¹ (177 ÷ 186)	
GE	3/4"	G 3/4	24,5 (0.9645)	20 (0.7873)	30 ^{+2,5} (266 ÷ 288)	
GF	1"	G 1	30,5 (1.2007)	22 (0.8661)	50 ^{+2,5} (443 ÷ 465)	
GG	1" 1/4	G 1 1/4	39 (1.5354)	24 (0.9448)	60 ⁺⁵ (531 ÷ 575)	
GH	1" 1/2	G 1 1/2	45 (1.7716)	26 (1.0236)	70 ⁺⁵ (620 ÷ 664)	
GL	2"	G 2	57 (2.2440)	32 (1.2598)	150 ⁺¹⁰ (1328 ÷ 1416)	

01/07.2010

INLET PORTS

NPT THREAD

NPT

NPT thread (60°) in accordance with ANSI - ASME B1-20

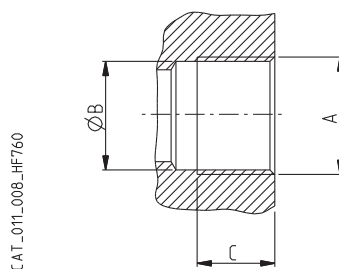

CODE	Nominal size	A	Ø B		C	Nm (lbf in)
			mm	(in)		
NC	3/8"	3/8 NPT	14,75	(0.5807)	10 (0.3936)	5 ⁺¹ (44 ÷ 53)
ND	1/2"	1/2 NPT	18	(0.7086)	13 (0.5118)	10 ⁺¹ (88 ÷ 97)
NE	3/4"	3/4 NPT	23,5	(0.9251)	14 (0.5511)	25 ⁺¹ (221 ÷ 230)
NF	1"	1 NPT	29,5	(1.1614)	17 (0.6692)	30 ^{+2,5} (265 ÷ 287)
NG	1" 1/4	1 1/4 NPT	38,5	(1.5157)	18 (0.7086)	50 ^{+2,5} (442 ÷ 464)
NH	1" 1/2	1 1/2 NPT	44	(1.7322)	18,5 (0.7283)	70 ⁺⁵ (620 ÷ 664)
NL	2"	2 NPT	57	(2.2440)	19,5 (0.7677)	130 ⁺⁵ (1150 ÷ 1195)

SAE J514 THREAD

ODT

American thread UNC-UNF 60° in accordance with ANSI B 1.1

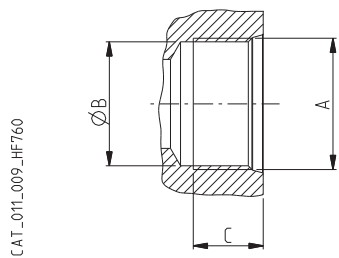

CODE	Nominal size	A	Ø B		C	Nm (lbf in)
			mm	(in)		
OA	3/8"	9/16" - 18 UNF- 2B	12,75	(0.5019)	12 (0.4724)	15 ⁺¹ (133 ÷ 142)
OB	1/2"	3/4" - 16 UNF - 2B	17,3	(0.6811)	15 (0.5905)	20 ⁺¹ (177 ÷ 186)
OD	3/4"	1 1/16" - 12 UNF - 2B	24,7	(0.9724)	20 (0.7873)	40 ^{+2,5} (354 ÷ 376)
OF	1"	1 5/16" - 12 UNF - 2B	30,5	(1.2007)	20 (0.7873)	60 ⁺⁵ (531 ÷ 575)
OG	1" 1/4	1 5/8" - 12 UNF - 2B	39,1	(1.5393)	20 (0.7873)	70 ⁺⁵ (620 ÷ 664)
OH	1" 1/2	1 7/8" - 12 UNF - 2B	45,3	(1.7834)	20 (0.7873)	100 ⁺⁵ (885 ÷ 929)
OI	2"	2 1/2" - 12 UNF - 2B	61,3	(2.4133)	20 (0.7873)	150 ⁺¹⁰ (1328 ÷ 1416)

01/07.2010

INLET PORTS

SAE FLANGED PORTS J518 - Standard pressure series 3000 PSI

SSM

Metric thread ISO 60° in accordance with ISO/R 262

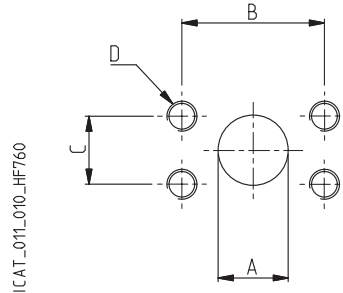

CODE	Nominal size	Ø A	B	C	D	Nm (lbf in)
		mm (in)	mm (in)	mm (in)	Thread Depth mm(in)	
MD	1 1/4	31,8 (1.252)	58,7 (2.311)	30,2 (1.189)	M 10 15,0 (0.591)	20 ⁺¹ (177 ÷ 186)
ME	1 1/2	38,1 (1.252)	69,8 (2.748)	35,7 (1.406)	M 12 18,0 (0.709)	30 ^{+2,5} (265 ÷ 287)
MF	2	50,8 (2.000)	77,8 (3.063)	42,9 (1.689)	M 12 18,0 (0.709)	30 ^{+2,5} (265 ÷ 287)
MG	2 1/2	64 (2.520)	88,9 (3.500)	50,8 (2.000)	M 12 18,0 (0.709)	30 ^{+2,5} (265 ÷ 287)

SAE FLANGED PORTS J518 - Standard pressure series 3000 PSI

SSS

American thread UNC-UNF 60° in accordance with ANSI B 1.1

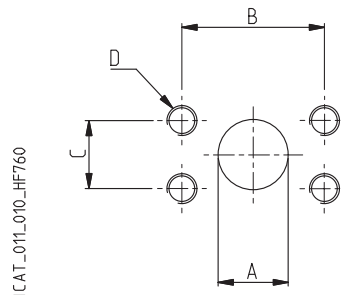

CODE	Nominal size	Ø A	B	C	D	Nm (lbf in)
		mm (in)	mm (in)	mm (in)	Thread Depth mm(in)	
SD	1 1/4	31,8 (1.252)	58,7 (2.311)	30,2 (1.189)	7/16-14 UNC-2B 16,0 (0.630)	30 ^{+2,5} (265 ÷ 287)
SE	1 1/2	38,1 (1.252)	69,8 (2.748)	35,7 (1.406)	1/2-13 UNC-2B 18,0 (0.709)	30 ^{+2,5} (265 ÷ 287)
SF	2	50,8 (2.000)	77,8 (3.063)	42,9 (1.689)	1/2-13 UNC-2B 18,0 (0.709)	30 ^{+2,5} (265 ÷ 287)
SG	2 1/2	64 (2.520)	88,9 (3.500)	50,8 (2.000)	1/2-13 UNC -2B 18,0 (0.709)	30 ^{+2,5} (265 ÷ 287)

01/07.2010

ASSEMBLY AND REPLACING ELEMENT INSTRUCTIONS

MOUNTING

Once you have checked the integrity of the filter inside its package, proceed as follow:

- A Take off the protection cap from the inlet port.
- B Secure the filter in the tank through the holes in the body's flange (pos.2) tightening them as follows:
 HF502-10 e HF502-20 = 44 lbf in (5 Nm)
 HF502-30 e HF508-30 = 62 lbf in (7 Nm)
 HF502-40 e HF508-40 = 88 lbf in (10 Nm)
- C Connect the piping of the return line to the inlet port using the tightening torque indicated on pages 32, 33 and 34.
- D In the presence of secondary inlet ports, prepare the required connections.
- E If the filter has a clogging indicator (pos.11 - 13 - 14 - 15), take the protection cap off and screw the indicator in the dedicated seat, then tighten to a tightening torque of 266 lbf in (30 Nm). If the indicator is electric, complete the required connections.
- F Start the circuit for a few minutes.
- G Make sure there are no leaks.

REPLACING ELEMENT

Once the working hour limit indicated in the maintenance instructions of the system is reached or when the clogging indicators point out the limit pressure drop created inside the filter, the element must be replaced. Pay attention to the drainage of hydraulic oil, therefore prepare suitable containers to collect it.

Proceed as follows:

- A Stop the system in "machine stopped" status.
- B Secure any shut-off valves on the hydraulic circuit.
- C Unscrew the cover's screw (pos.12) and take off the closing cap (pos.9).
- D Remove the clogged filtering element (pos.6) and clean the bowl's bottom (pos.4) from the residual particles left during the functioning.
- E Check out that the O-rings (pos.3, 5, 8) are not damaged, otherwise replace them and consequently position the new ones correctly..
- F In case of leakages between the tank and the filter's body (pos.2) check out the O-ring's condition (pos.1). If it is damaged replace it and consequently position the new one correctly.
- G Insert the new filtering element pre-emptively lubricating the O-Ring (pos. 5).
- H Insert the placement spring (pos.7) in the dedicated seat of the filter's cover (pos.9). Reassemble it using the fixing screws (pos.12) with a tightening torque of 44 lbf in (5 Nm).
- I Re-open the eventual valves closed before.
- L Start the machine for a few minutes.
- M Make sure there are no leaks.

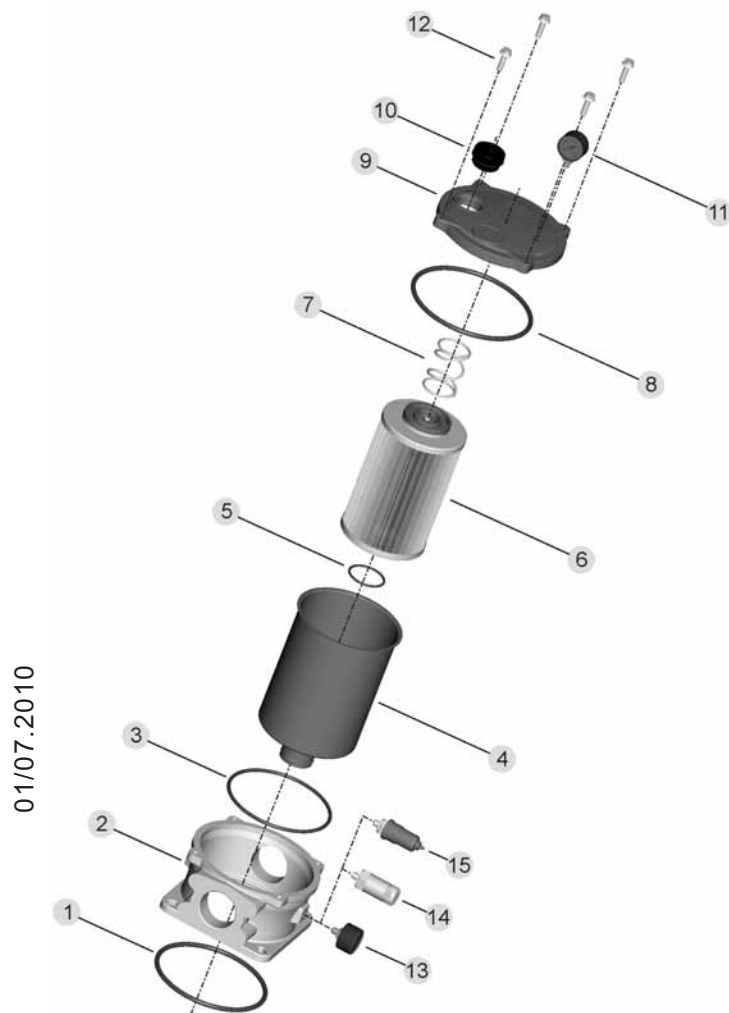

Pos. Description

- | | |
|----|----------------------------|
| 1 | Filter's body O-ring |
| 2 | Filter's body |
| 3 | Bowl O-Ring |
| 4 | Bowl |
| 5 | O-Ring di tenuta cartuccia |
| 6 | Filtering element |
| 7 | Placement spring |
| 8 | Cover's O-ring |
| 9 | Closing cap |
| 10 | Filler cap |
| 11 | Radial manometer |
| 12 | Cover's fixing screws |
| 13 | Rear Manometer |
| 14 | Visual indicator |
| 15 | Electrical indicator |

When ordering spare parts, always specify the reference number, the filter code and quantity.
 Example: Spare parts pos. 8 - HHR80000 - Q.ty 3

HOW TO ORDER A COMPLETE FILTER HF 502

1	2	3	4	5	6	7	8		
HF502-	20.122	- AS	- FG010	- B17	- GG	- B	- H	- Z	-
9	10	11	12	13	14				
XA		- GA	- M	- YD	- GE	- K			

1	Filter type	CODE
	See table from pag. 23 to pag. 26	HF502..
2	Filtering surface	CODE
	Standard	AS
	Oversize	FS
3	Degree of filtration	CODE
	3 [µm] Micro-fibre glass	FG003
	6 [µm] Micro-fibre glass	FG006
	10 [µm] Micro-fibre glass	FG010
	25 [µm] Micro-fibre glass	FG025
	25 [µm] Stainless steel wire mesh	MI025
	60 [µm] Stainless steel wire mesh	MI060
	125[µm] Stainless steel wire mesh	MI125
	90 [µm] Steel wire mesh	MS090
	10 [µm] Cellulose	SP010
	25 [µm] Cellulose	SP025
	10 [µm] Reinforced cellulose	RP010
	25 [µm] Reinforced cellulose	RP025
4	By-pass setting valve	CODE
	With By-pass setting valve 25 [psi] (1,7 [bar])	B17
	With By-pass setting valve 51 [psi] (3,5 [bar])	B35
5	Inlet port	CODE
	GAS threads (BSPP)	
	G 3/8	GC
	G 1/2	GD
	G 3/4	GE
	G 1	GF
	G 1 1/4	GG
	G 1 1/2	GH
	G 2	GL
	NPT threads	
	3/8	NC
	1/2	ND
	3/4	NE
	1	NF
	1 1/4	NG
	1 1/2	NH
	2	NL
	SAE threads ODT	
	3/8	OA
	1/2	OB
	3/4	OD
	1	OF
	1 1 /4	OG
	1 1/2	OH
	2	OI

6	Seals	CODE
	Buna	B
	Viton	V
7	Filler cap	CODE
	Without	H
	With filler cap (except HF502-10)	L
8	Magnetic set	CODE
	Without	Z
	With magnetic set	R
9	Indicators arranged	CODE
	Without	XN
	On the housing - right (1)(except HF502-10 and HF502-30)	XA
	On the housing - left (2)	XB
	On the cover (3)	XD
10	Indicator's ports dimensions	CODE
	GAS Threads (BSPP)	
	G 1/8	GA
	G 1/8 with plug	DA
11	Indicators	CODE
	Without	G
	Manometer - rear connection	M
	Manometer - radial connection	N
	Visual indicator	P
	Electrical indicator	S
12	Secondary ports	CODE
	Without	YN
	On the housing - right (1)(except HF502-10 / 20 / 30)	YA
	On the housing - left (2)(except HF502-10 / 20 / 30)	YB
	On the housing - front-left (5)(only for HF502-30)	YC
	On the cover (4)	YD
13	Secondary ports dimensions	CODE
	G 3/8	GC
	G 1/2 (except HF502-10)	GD
	G 3/4 (except HF502-10)	GE
	G 1 (only for HF502-40)	GF
	G 1 1/4 (only for HF502-40)	GG
14	Accessories	CODE
	Without	K
	With diffuser	D
	With bowl extension(ex. bowl extension lenght 150=P150)	P...
	With level dipstick(ex. level dipstick lenght 175=L175)	L...

<input checked="" type="checkbox"/> Standard	<input type="checkbox"/> On request
--	-------------------------------------

01/07.2010

HOW TO ORDER A COMPLETE FILTER HF 508

1	2	3	4	5	6	7	8
HF508-	40.390	- AS	- FG010	- B17	- MG / MF	- B	- H
9	10	11	12	13	14	15	
Z	- XA	- GA	- M	- YB	- GD	- K	

1	Filter type	CODE
	See table from pag. 27 to pag. 28	HF508..
2	Filtering surface	CODE
	Standard	AS
	Oversize	FS
3	Degree of filtration	CODE
	3 [µm] Micro-fibre glass	FG003
	6 [µm] Micro-fibre glass	FG006
	10 [µm] Micro-fibre glass	FG010
	25 [µm] Micro-fibre glass	FG025
	25 [µm] Stainless steel wire mesh	MI025
	60 [µm] Stainless steel wire mesh	MI060
	125[µm] Stainless steel wire mesh	MI125
	90 [µm] Steel wire mesh	MS090
	10 [µm] Cellulose	SP010
	25 [µm] Cellulose	SP025
	10 [µm] Reinforced cellulose	RP010
	25 [µm] Reinforced cellulose	RP025
4	By-pass setting valve	CODE
	With By-pass setting valve 25 [psi] (1,7 [bar])	B17
	With By-pass setting valve 51 [psi] (3,5 [bar])	B35
5	Main inlet port	CODE
6	Supplementary inlet port	CODE
	GAS threads (BSPP)	
	G 1 1/4	GG
	G 1 1/2	GH
	G 2	GL
	NPT threads	
	1 1/4	NG
	1 1/2	NH
	2	NL
	SAE threads ODT	
	1 1/4	OG
	1 1/2	OH
	2	OI
	Flanged SAE (SSM) - 3000 PSI	
	1 1/4	MD
	1 1/2	ME
	2	MF
	2 1/2 (only for main inlet port HF 508-40)	MG
	Flanged SAE (SSS) - 3000 PSI	
	1 1/4	SD
	1 1/2	SE
	2	SF
	2 1/2 (only for main inlet port HF 508-40)	SG
	Only for supplementary inlet port	
	Blind unmachined port	00

7	Seals	CODE
	Buna	B
	Viton	V
8	Filler cap	CODE
	Without	H
	With filler cap	L
9	Magnetic set	CODE
	Without	Z
	With magnetic set	R
10	Indicators arranged	CODE
	Without	XN
	On the housing - right (1)	XA
	On the housing - left (2)	XB
	On the cover (3)	XD
11	Indicator's ports dimensions	CODE
	GAS threads (BSPP)	
	G 1/8	GA
	G 1/8 with plug	DA
12	Indicators	CODE
	Without	G
	Manometer - rear connection	M
	Manometer - radial connection	N
	Visual Indicator	P
	Electrical indicator	S
13	Secondary ports	CODE
	Senza	YN
	On the housing - right (1)	YA
	On the housing - left (2)	YB
	On the cover (4)	YD
14	Secondary ports dimensions	CODE
	G 3/8	GC
	G 1/2	GD
	G 3/4	GE
	G 1 (only for HF 508-40)	GF
	G 1 1/4 (only for HF508-40)	GG
15	Accessories	CODE
	Without	K
	With diffuser	D
	With bowl extension(ex. bowl extension lenght 150=P150)	P...
	With level dipstick(ex. level dipstick lenght 175=L175)	L...

<input checked="" type="checkbox"/>	Standard	<input type="checkbox"/>	On request
-------------------------------------	----------	--------------------------	------------

01/07.2010

HOW TO ORDER A REPLACEMENT ELEMENT

1	2	3	4	5	6	
HEK02-	20.201	- AS	- FG010	- VM	- B17	- B

1	Element type	CODE
	See table pag. 29	HE K02..

2	Filtering surface	CODE
	Standard	AS
	Oversize	FS

3	Degree of filtration	CODE
	3 [µm] Micro-fibre glass	FG003
	6 [µm] Micro-fibre glass	FG006
	10 [µm] Micro-fibre glass	FG010
	25 [µm] Micro-fibre glass	FG025
	25 [µm] Stainless steel wire mesh	MI025
	60 [µm] Stainless steel wire mesh	MI060
	125[µm] Stainless steel wire mesh	MI125
	90 [µm] Steel wire mesh	MS090
	10 [µm] Cellulose	SP010
	25 [µm] Cellulose	SP025
	10 [µm] Reinforced cellulose	RP010
	25 [µm] Reinforced cellulose	RP025

4	By-pass valve	CODE
	With valve and spring	VM
	With valve - without spring	VV

5	By-pass setting valve	CODE
	With By-pass setting valve 25 [psi] (1,7 [bar])	B17
	With By-pass setting valve 51 [psi] (3,5 [bar])	B35

6	Seals	CODE
	Buna	B
	Viton	V

Standard
 On request